

# optibelt

**Metall  
Metal**

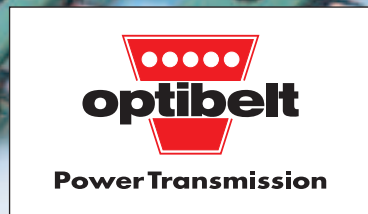

Gültig ab Effective from 01. 03. 2006



**Price List**

**Preisliste**

	Seite
<b>optibelt TB</b> Taper-Buchsen.....	3
Ausführungen der <b>optibelt K5</b> Keilrillenscheiben, Auswuchten, Aufschläge für Fertigbohrungen.....	4
<b>optibelt K5</b> Keilrillenscheiben für Taper-Buchsen – Rillen nach DIN 2211 .....	5-12
<b>optibelt K5</b> Keilrillenscheiben für zylindrische Bohrung – Rillen nach DIN 2211 .....	13-18
<b>optibelt RE</b> Regelscheiben.....	19-21
<b>optibelt RBS</b> Keilrippenscheiben für Taper-Buchsen .....	22-26
<b>optibelt RBS</b> Keilrippenscheiben für zylindrische Bohrung.....	26
<b>optibelt F5</b> Flachriemenscheiben für Taper-Buchsen .....	27
<b>optibelt MS</b> Motorspannschienen .....	28
<b>optibelt MS</b> Motorspannschlitten.....	29
<b>optibelt ZRS</b> Standard-Zahnscheiben für zylindrische Bohrung.....	30-35
<b>optibelt ZRS</b> Standard-Zahnscheiben für Taper-Buchsen .....	36-41
<b>optibelt ZRS</b> HTD®-Zahnscheiben für zylindrische Bohrung.....	42-49
<b>optibelt ZRS</b> HTD®-Zahnscheiben für Taper-Buchsen .....	50-55
<b>optibelt ZRS</b> Metrische Zahnscheiben für zylindrische Bohrung, T-Type.....	56-60
<b>optibelt ZRS</b> Metrische Zahnscheiben für zylindrische Bohrung, AT-Type ..	61-64
<b>optibelt ZRW</b> Standard-Zahnwellen .....	65-66
<b>optibelt ZRW</b> Metrische Zahnwellen.....	67-68
<b>optibelt TN</b> Tapernaben .....	69
<b>optibelt TN</b> Zwischenhülsen.....	70
<b>optibelt CE</b> Spannelemente .....	71-86

	Page
<b>optibelt TB</b> Taper bushes.....	3
Types of <b>optibelt K5</b> V-grooved pulleys, balancing, surcharges for finished bores .....	4
<b>optibelt K5</b> V-grooved pulleys for taper bushes – grooves to ISO/BS/DIN .....	5-12
<b>optibelt K5</b> V-grooved pulleys for plain boring – grooves to ISO/BS/DIN.....	13-18
<b>optibelt RE</b> Variable speed pulleys.....	19-21
<b>optibelt RBS</b> Ribbed belt pulleys for taper bushes.....	22-26
<b>optibelt RBS</b> Ribbed belt pulleys for plain boring.....	26
<b>optibelt F5</b> Flat belt pulleys for taper bushes.....	27
<b>optibelt MS</b> Motor slide rails.....	28
<b>optibelt MS</b> Motor slide bases.....	29
<b>optibelt ZRS</b> Timing belt pulleys for plain boring.....	30-35
<b>optibelt ZRS</b> Timing belt pulleys for taper bushes.....	36-41
<b>optibelt ZRS</b> HTD® pulleys for plain boring.....	42-49
<b>optibelt ZRS</b> HTD® pulleys for taper bushes.....	50-55
<b>optibelt ZRS</b> Metric timing belt pulleys for plain boring, T sections .....	56-60
<b>optibelt ZRS</b> Metric timing belt pulleys for plain boring, AT sections .....	61-64
<b>optibelt ZRW</b> Timing bars – standard timing belts ...	65-66
<b>optibelt ZRW</b> Timing bars – metric timing belts .....	67-68
<b>optibelt TN</b> Taper hubs.....	69
<b>optibelt TN</b> Adapters .....	70
<b>optibelt CE</b> Clamping bushes .....	71-86

Die Preise dieser Liste stellen keine Preisempfehlung für den Weiterverkauf dar. **Versandkosten zu Lasten des Empfängers.** Bezüglich der Haftung und Lieferung verweisen wir auf unsere allgemeinen Geschäftsbedingungen. Mit Erscheinen dieser Liste verlieren alle früheren Preislisten ihre Gültigkeit, dies gilt auch für vorhergehende Auflagen. Änderungen auf Grund technischer Neuerungen sowie Irrtum vorbehalten. Nachdruck verboten. Zuwiderhandlungen werden urheberrechtlich verfolgt.

*The prices in this list are not for resale use. Freight charges are the responsibility of the customer. Refer to our "General Conditions of Sale" for matters concerning liability and delivery. With the introduction of this list all other price lists are superceded. Alterations due to error or to technical improvements are excepted.*

*Reprinting or photocopying forbidden. Violations of copyright will be prosecuted.*

Taper-Buchsen mit metrischer Bohrung, Nut nach DIN 6885 Teil 1 Taper bushes with metric bores. Keyways to DIN 6885 Part 1																
	Taper-Buchse Taper bush															Material: EN-GJL 200 – DIN EN 1561
	1008	1108	1210	1215	1310	1610	1615	2012	2517	3020	3030	3525	3535	4040	4545	5050
Bohrungs- durch- messer Bore diameter d <sub>2</sub> (mm)	10	10	11	11	14	14	14	14	16	25	35	35	35	40	55	70
	11	11	12	12	16	16	16	16	18	28	38	38	38	42	60	75
	12	12	14	14	18	18	18	18	19	30	40	40	40	45	65	80
	14	14	16	16	19	19	19	19	20	32	42	42	42	48	70	85
	16	16	18	18	20	20	20	20	22	35	45	45	45	50	75	90
	18	18	19	19	22	22	22	22	24	38	48	48	48	55	80	95
	19	19	20	20	24	24	24	24	25	40	50	50	50	60	85	100
	20	20	22	22	25	25	25	25	28	42	55	55	55	65	90	105
	22	22	24	24	28	28	28	28	30	45	60	60	60	70	95	110
	24▲	24	25	25	30	30	30	30	32	48	65	65	65	75	100	115
	25▲	25	28	28	32	32	32	32	35	50	70	70	70	80	105	120
		28▲	30	30	35	35	35	35	38	55	75	75	75	85	110	125
			32	32		38	38	38	40	60	80	80	80	90		
						40	40	40	42	65	85	85	85	95		
						42▲	42▲	42	45	70	90	90	90	100		
								45	48							
								48	50							
								50	55							
								60	60							
Anzug Tighten- ing torque (N <sub>m</sub> )	5,7	5,7	20	20	20	20	20	31	49	92	92	115	115	172	195	275
Buchsenlänge Bush length (mm)	22,3	22,3	25,4	38,1	25,4	25,4	38,1	31,8	44,5	50,8	76,2	63,5	88,9	101,6	114,3	127,0
Gewicht bei Weight at d <sub>2 min</sub> (= kg)	0,12	0,16	0,28	0,39	0,32	0,41	0,60	0,75	1,06	2,50	3,75	3,90	5,13	7,68	12,70	15,17
€ Stück each	<b>6,90</b>	<b>7,90</b>	<b>10,40</b>	<b>13,00</b>	<b>13,20</b>	<b>12,40</b>	<b>13,00</b>	<b>15,20</b>	<b>19,10</b>	<b>24,80</b>	<b>32,50</b>	<b>66,00</b>	<b>62,60</b>	<b>88,00</b>	<b>112,00</b>	<b>179,00</b>

▲ Diese Bohrung ist mit Flachnut ausgeführt. These bores have shallow keyways.

**Flachnute für Taper-Buchsen Shallow keyways for taper bushes**

Bohrungsdurchm. Bore diameter d <sub>2</sub> (mm)	Nutbreite Keyway width b (mm)	Nuttiefe Keyway depth t <sub>2</sub> (mm)	Bohrungsdurchm. Bore diameter d <sub>2</sub> (mm)	Nutbreite Keyway width b (mm)	Nuttiefe Keyway depth t <sub>2</sub> (mm)
24	8	2,0	28	8	2,0
25	8	1,3	42	12	2,2

Taper-Buchsen mit Zoll-Bohrung, Nut nach Britischem Standard BS 46 Teil 1 Taper bushes with inch bores. Keyways to BS 46 Part 1																	
	Taper-Buchse Taper bush															Material: EN-GJL 200 – DIN EN 1561	
	1008	1108	1210	1215	1310	1610	1615	2012	2517	3020	3030	3525	3535	4040	4545	5050	
Bohrungs- durch- messer Bore diameter d <sub>2</sub> (Zoll inch)	3/8*	3/8*	1/2	5/8*	1/2*	1/2	1/2	5/8*	3/4	1 1/4	1 1/4	1 1/2*	1 1/2	1 3/4*	2 1/4*	3*	
	1/2	1/2	5/8	3/4	5/8*	5/8	5/8	3/4	7/8	1 3/8	1 3/8	1 5/8*	1 5/8	1 7/8*	2 3/8*	3 1/4*	
	5/8	5/8	3/4	7/8	3/4*	3/4	3/4	7/8	1	1 1/2	1 1/2	1 3/4*	1 3/4	2*	2 1/2*	3 1/2*	
	3/4	3/4	7/8	1	7/8*	7/8	7/8*	1	1 1/8	1 5/8	1 5/8	1 7/8*	1 7/8	2 1/8*	2 3/4*	3 3/4*	
	7/8*	7/8	1	1 1/8	1*	1	1	1 1/8	1 1/4	1 3/4*	1 3/4*	2*	2	2 1/4*	2 7/8*	4*	
	1▲	1	1 1/8	1 1/4	1 1/8	1 1/8	1 1/8	1 1/4	1 3/8	1 7/8	1 7/8	2 1/8*	2 1/8	2 3/8*	3*	4 1/4*	
		1 1/8▲*	1 1/4		1 1/4	1 1/4	1 1/4	1 3/8	1 1/2	1 5/8	2	2 1/8*	2 1/8	2 3/8	3 1/4*	4 1/2*	
					1 3/8	1 3/8	1 3/8	1 7/8	1 1/2	1 5/8	2 1/8*	2 1/8*	2 3/8*	2 3/8	2 5/8*	3 3/8*	4 3/4*
						1 1/2	1 1/2	1 5/8	1 3/4	1 3/4	1 7/8	2 1/8*	2 1/8*	2 3/8	2 7/8*	3 1/2*	5*▲
						1 5/8	1 5/8▲*	1 3/4	1 7/8	2	2 1/8	2 1/2	2 3/4*	2 3/4	3*	4*	
									1 7/8	2	2 1/8	2 1/2	2 3/4*	2 3/4	3 1/8*	4 1/4*▲	
									2	2 1/4	2 3/4	2 3/4*	3	3	3 1/4*	4 1/2*▲	
									2 3/8	2 3/8	2 7/8	2 7/8	3 1/8*	3 1/8	3 3/8*		
									2 1/2	3	3	3	3 1/4*	3 1/4	3 1/2*		
													3 3/8*	3 3/8	3 3/4*▲		
												3 1/2*▲	3 1/2▲	4*▲			
Anzug Tighten- ing torque (N <sub>m</sub> )	5,7	5,7	20	20	20	20	20	31	49	92	92	115	115	172	195	275	
Buchsenlänge Bush length (mm)	22,3	22,3	25,4	38,1	25,4	25,4	38,1	31,8	44,5	50,8	76,2	63,5	88,9	101,6	114,3	127,0	
Gewicht bei Weight at d <sub>2 min</sub> (= kg)	0,12	0,16	0,28	0,39	0,32	0,41	0,60	0,75	1,06	2,50	3,75	3,90	5,13	7,68	12,70	15,17	
€ Stück each	<b>6,90</b>	<b>7,90</b>	<b>10,40</b>	<b>13,00</b>	<b>13,20</b>	<b>12,40</b>	<b>13,00</b>	<b>15,20</b>	<b>19,10</b>	<b>24,80</b>	<b>32,50</b>	<b>66,00</b>	<b>62,60</b>	<b>88,00</b>	<b>112,00</b>	<b>179,00</b>	

\* Keine Lagerware Non stock items

▲ Diese Bohrung ist mit Flachnut ausgeführt. These bores have shallow keyways.

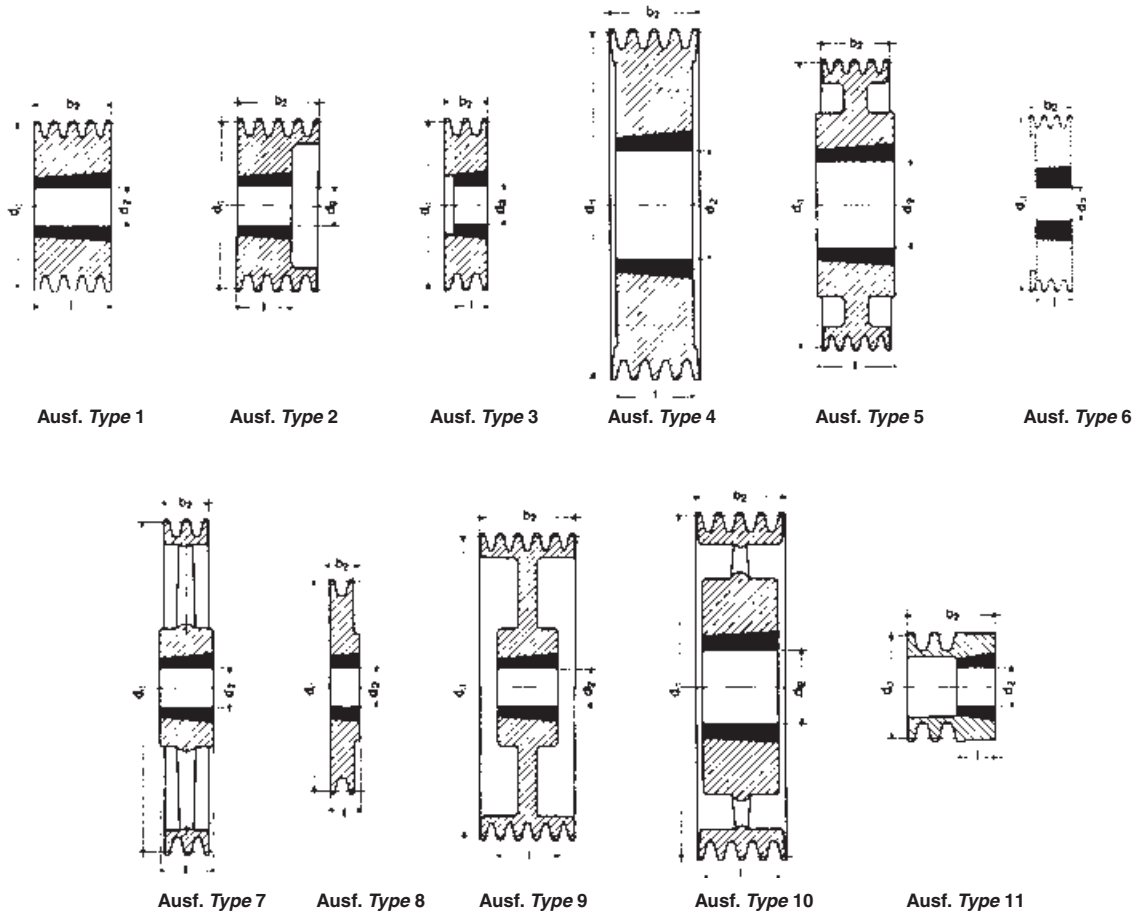

Fertigungstechnische Änderungen der Ausführungen vorbehalten.  
 We reserve the right to make technical changes.

**Auswuchten**

Die Listenpreise gelten für in einer Ebene nach DIN/ISO 1940 ausgewuchtete GG-Scheiben wie folgt:  
 Gütestufe G 6,3 für  $\varnothing d_d \leq 400$  mm bei  $n = 1500$  min<sup>-1</sup>, für  $\varnothing d_d > 400$  mm bei  $v = 30$  m/s.

Die Auswuchtung wird ohne Nut auf glattem Wuchtdorn vorgenommen. Für Maschinen, deren Läufer mit einer in das Wellenende eingesetzten vollen Passfeder ausgewuchtet sind, muss mit folgendem Vermerk bestellt werden: »Ausgewuchtet mit Fertigbohrung und leerer Nut auf glattem Wuchtdorn ohne eingesetzte Passfeder«.

Ein Auswuchten in zwei Ebenen Gütestufe G 6,3 oder feiner ist erforderlich, wenn  $v \geq 30$  m/s oder das Verhältnis Richtdurchmesser zu Kranzbreite  $d_d : b_2 < 4$  ist bei  $v > 20$  m/s.

Mehrpreis auf Anfrage nach Bekanntgabe der Betriebsdrehzahl.

**Balancing**

The list prices apply, as per VDI 2060, to cast iron pulleys balanced in one plane as follows:  
 Grade G 6.3 for  $\varnothing d_d \leq 400$  mm at  $n = 1500$  rpm, for  $\varnothing d_d > 400$  mm at  $v = 30$  m/sec.

Balancing is carried out minus the key on a smooth mandrel. Machines where the rotors are balanced with an adjusting spring inserted in the shaft end must be ordered as follows: "Balanced with finished bore without key on a smooth mandrel without inserted spring".

We recommend balancing in two planes grade G 6.3 or better if  $v \leq 30$  m/sec. or if the ratio between datum diameter and pulley face width  $d_d : b_2 < 4$  at  $v > 20$  m/sec.

Surcharges for balancing on request. Please give pulley operating speed.

**Aufschläge für Fertigbohrung H7 und Passfedernut nach DIN 6885 Teil 1**  
**Surcharges for finished bore H7 and keyway to DIN 6885 part 1**

Stück Quantity	Fertigbohrung bis 30 mm Finished bore up to 30 mm		Fertigbohrung 31 bis 50 mm Finished bore 31 to 50 mm		Fertigbohrung 51 bis 75 mm Finished bore 51 to 75 mm		Gewindebohrung für Stellschraube Drilled and tapped for setscrews
	ohne Nut without keyway	mit Nut with keyway	ohne Nut without keyway	mit Nut with keyway	ohne Nut without keyway	mit Nut with keyway	
	€ Stück each	€ Stück each	€ Stück each	€ Stück each	€ Stück each	€ Stück each	
1 bis to 2	63,70	79,70	91,40	111,00	114,00	143,00	32,20
3 bis to 5	55,00	69,20	78,80	96,10	98,50	123,00	26,20
6 bis to 10	47,20	59,90	68,80	83,10	85,50	107,00	22,20
11 bis to 24	44,30	55,90	63,70	77,50	79,30	99,80	19,90
25 bis to 50	40,10	51,20	58,70	70,70	72,80	91,40	17,80
über over 50	37,70	47,20	54,40	65,80	67,60	85,20	16,70

Sonderbearbeitungen und Sonderscheiben auf Anfrage. *Special pulleys and custom designed pulleys on request.*

**Profil Section SPZ/10**

Richt- durchmesser Datum diameter d <sub>2</sub> (mm)	Anzahl der Rillen No. of grooves	Ausführung Type		Gewicht ohne Buchse Weight without bush (= kg)	Taper- Buchse Taper bush	€ Stück ohne Buchse each without bush	Richt- durchmesser Datum diameter d <sub>2</sub> (mm)	Anzahl der Rillen No. of grooves	Ausführung Type		Gewicht ohne Buchse Weight without bush (= kg)	Taper- Buchse Taper bush	€ Stück ohne Buchse each without bush		
50▲	1	●	11	0,3	1008	21,30	118	1	●	8	0,9	1610	28,00		
	2	●	11	0,4	1008	26,00		2	●	6	1,3	1610	31,20		
56▲	1	●	11	0,4	1008	17,00		3	●	6	1,6	2012	38,90		
	2	●	11	0,5	1108	19,50		4	●	6	1,8	2012	44,00		
60	1	●	11	0,2	1008	17,50		5	●	6	1,8	2012	54,90		
	2	●	11	0,6	1108	20,40		6*	●	6	2,0	2517	58,00		
63	1	●	8	0,2	1108	18,30		125	1	●	8	1,0	1610	29,80	
	2	●	6	0,3	1108	21,30			2	●	6	1,4	1610	32,50	
	3	●	6	0,4	1108	27,30			3	●	2	1,8	2012	40,00	
67	1	●	8	0,3	1108	18,40			4	●	2	2,2	2012	47,50	
	2	●	6	0,4	1108	22,20			5	●	6	2,3	2012	55,80	
	3	●	6	0,5	1108	28,00			6*	●	6	2,5	2517	60,60	
71	1	●	8	0,3	1108	18,60			132	1	●	8	1,1	1610	31,20
	2	●	6	0,4	1108	22,70				2	●	6	1,5	1610	33,00
	3	●	6	0,6	1108	28,70				3	●	2	2,3	2012	41,20
75	1	●	8	0,4	1108	19,30		4		●	2	2,5	2012	48,80	
	2	●	6	0,4	1210	22,90		5		●	6	2,7	2517	56,70	
	3	●	6	0,5	1210	29,10		6*		●	6	2,9	2517	62,80	
80	1	●	8	0,5	1210	19,50	140	1		●	8	1,2	1610	32,10	
	2	●	6	0,6	1210	23,70		2		●	2	1,7	1610	35,80	
	3	●	6	0,7	1210	29,80		3		●	2	2,6	2012	43,60	
	4	●	6	0,8	1210	31,40		4		●	2	2,9	2012	50,10	
85	1	●	8	0,6	1210	20,00		5		●	2	3,2	2517	58,50	
	2	●	6	0,5	1610	23,80		6*		●	2	3,5	2517	65,00	
	3	●	6	0,6	1610	30,50		8*	●	4	4,0	2517	119,00		
	4	●	6	0,9	1610	37,10		150	1	●	8	1,2	1610	33,70	
	5	●	6	1,0	1610	44,40			2	●	8	2,0	2012	37,60	
90	1	●	8	0,7	1210	20,40			3	●	2	3,1	2012	45,70	
	2	●	6	0,7	1610	24,50	4		●	2	3,7	2517	53,20		
	3	●	6	0,8	1610	31,20	5		●	2	4,0	2517	60,90		
	4	●	6	1,0	1610	39,30	6*		●	2	4,4	2517	65,80		
	5	●	6	1,2	1610	44,80	8*		●	4	5,1	2517	123,00		
95	1	●	8	0,7	1210	22,70	160		1	●	8	1,3	1610	35,90	
	2	●	6	0,8	1610	25,10			2	●	8	2,5	2012	39,60	
	3	●	6	0,9	1610	31,50			3	●	2	3,6	2012	47,50	
	4	●	6	1,1	1610	40,20		4	●	2	4,4	2517	54,50		
	5	●	6	1,3	1610	45,70		5	●	2	4,8	2517	64,10		
100	1	●	8	0,8	1210	23,80		6*	●	2	5,2	2517	71,10		
	2	●	6	0,9	1610	26,90		8*	●	4	5,6	2517	134,00		
	3	●	6	1,1	1610	33,20		170	1	●	8	1,5	1610	38,60	
	4	●	6	1,1	1610	40,70			2	●	8	2,5	2012	45,30	
	5	●	6	1,3	2012	47,90			3	○	9	4,2	2012	53,20	
	6*	●	6	1,4	2012	49,70	4		○	9	5,3	2517	62,00		
106	1	●	8	0,9	1610	24,30	5		●	2	5,3	2517	62,00		
	2	●	6	1,1	1610	28,70	6*		●	2	5,9	2517	90,40		
	3	●	6	1,3	1610	34,50	6*		●	2	6,5	2517	106,00		
	4	●	6	1,3	1610	42,30	180		1	●	8	1,6	1610	39,30	
	5	●	6	1,5	2012	49,70			2	●	8	2,5	2012	46,50	
	6*	●	6	1,6	2012	53,60			3	○	9	4,8	2012	53,90	
112	1	●	8	1,0	1610	26,30		4	○	9	6,1	2517	62,80		
	2	●	6	1,3	1610	29,80		5	○	9	6,3	2517	68,20		
	3	●	6	1,3	2012	35,80		6*	○	9	6,8	2517	76,40		
	4	●	6	1,5	2012	43,00		8*	○	4	7,1	3020	141,00		
	5	●	6	1,8	2012	52,70		190	1	●	8	1,8	1610	41,30	
	6*	●	6	1,9	2012	55,80			2	●	8	2,6	2012	50,10	
118	1	●	8	0,9	1610	26,30			3	○	9	4,9	2012	54,50	
	2	●	6	1,3	1610	29,80	4		○	9	5,3	2517	64,10		
	3	●	6	1,3	2012	35,80	5		○	9	6,3	2517	96,20		
	4	●	6	1,5	2012	43,00	6*		○	9	6,9	2517	113,00		
	5	●	6	1,8	2012	52,70	190		1	●	8	1,8	1610	41,30	
	6*	●	6	1,9	2012	55,80			2	●	8	2,6	2012	50,10	
125	1	●	8	0,9	1610	26,30			3	○	9	4,9	2012	54,50	
	2	●	6	1,3	1610	29,80			4	○	9	5,3	2517	64,10	
	3	●	6	1,3	2012	35,80		5	○	9	6,3	2517	96,20		
	4	●	6	1,5	2012	43,00		6*	○	9	6,9	2517	113,00		
	5	●	6	1,8	2012	52,70		190	1	●	8	1,8	1610	41,30	
	6*	●	6	1,9	2012	55,80			2	●	8	2,6	2012	50,10	
132	1	●	8	0,9	1610	26,30			3	○	9	4,9	2012	54,50	
	2	●	6	1,3	1610	29,80			4	○	9	5,3	2517	64,10	
	3	●	6	1,3	2012	35,80	5		○	9	6,3	2517	96,20		
	4	●	6	1,5	2012	43,00	6*		○	9	6,9	2517	113,00		
	5	●	6	1,8	2012	52,70	190		1	●	8	1,8	1610	41,30	
	6*	●	6	1,9	2012	55,80			2	●	8	2,6	2012	50,10	
140	1	●	8	0,9	1610	26,30			3	○	9	4,9	2012	54,50	
	2	●	6	1,3	1610	29,80			4	○	9	5,3	2517	64,10	
	3	●	6	1,3	2012	35,80		5	○	9	6,3	2517	96,20		
	4	●	6	1,5	2012	43,00		6*	○	9	6,9	2517	113,00		
	5	●	6	1,8	2012	52,70		190	1	●	8	1,8	1610	41,30	
	6*	●	6	1,9	2012	55,80			2	●	8	2,6	2012	50,10	
150	1	●	8	0,9	1610	26,30			3	○	9	4,9	2012	54,50	
	2	●	6	1,3	1610	29,80			4	○	9	5,3	2517	64,10	
	3	●	6	1,3	2012	35,80	5		○	9	6,3	2517	96,20		
	4	●	6	1,5	2012	43,00	6*		○	9	6,9	2517	113,00		
	5	●	6	1,8	2012	52,70	190		1	●	8	1,8	1610	41,30	
	6*	●	6	1,9	2012	55,80			2	●	8	2,6	2012	50,10	
160	1	●	8	0,9	1610	26,30			3	○	9	4,9	2012	54,50	
	2	●	6	1,3	1610	29,80			4	○	9	5,3	2517	64,10	
	3	●	6	1,3	2012	35,80		5	○	9	6,3	2517	96,20		
	4	●	6	1,5	2012	43,00		6*	○	9	6,9	2517	113,00		
	5	●	6	1,8	2012	52,70		190	1	●	8	1,8	1610	41,30	
	6*	●	6	1,9	2012	55,80			2	●	8	2,6	2012	50,10	
170	1	●	8	0,9	1610	26,30			3	○	9	4,9	2012	54,50	
	2	●	6	1,3	1610	29,80			4	○	9	5,3	2517	64,10	
	3	●	6	1,3	2012	35,80	5		○	9	6,3	2517	96,20		
	4	●	6	1,5	2012	43,00	6*		○	9	6,9	2517	113,00		
	5	●	6	1,8	2012	52,70	190		1	●	8	1,8	1610	41,30	
	6*	●	6	1,9	2012	55,80			2	●	8	2,6	2012	50,10	
180	1	●	8	0,9	1610	26,30			3	○	9	4,9	2012	54,50	
	2	●	6	1,3	1610	29,80			4	○	9	5,3	2517	64,10	
	3	●	6	1,3	2012	35,80		5	○	9	6,3	2517	96,20		
	4	●	6	1,5	2012	43,00		6*	○	9	6,9	2517	113,00		
	5	●	6	1,8	2012	52,70		190	1	●	8	1,8	1610	41,30	
	6*	●	6	1,9	2012	55,80			2	●	8	2,6	2012	50,10	
190	1	●	8	0,9	1610	26,30			3	○	9	4,9	2012	54,50	
	2</														

**Profil Section SPZ/10**

Richt- durchmesser Datum diameter d <sub>2</sub> (mm)	Anzahl der Rillen No. of grooves	Ausführung Type		Gewicht ohne Buchse Weight without bush (= kg)	Taper- Buchse Taper bush	€ Stück ohne Buchse each without bush	Richt- durchmesser Datum diameter d <sub>2</sub> (mm)	Anzahl der Rillen No. of grooves	Ausführung Type		Gewicht ohne Buchse Weight without bush (= kg)	Taper- Buchse Taper bush	€ Stück ohne Buchse each without bush	
200	1	●	8	2,3	2012	<b>42,80</b>	500	2	x	7	9,1	2517	<b>240,00</b>	
	2	●	8	2,8	2012	<b>52,30</b>		3	x	7	11,4	2517	<b>275,00</b>	
	3	○	9	3,5	2012	<b>55,30</b>		4	x	10	14,3	3020	<b>314,00</b>	
	4	○	9	4,7	2517	<b>65,00</b>		5	x	10	17,6	3020	<b>330,00</b>	
	5	○	9	5,5	2517	<b>73,40</b>		6*	x	10	19,9	3020	<b>429,00</b>	
	6*	○	9	6,1	2517	<b>81,60</b>		630	3*	x	7	15,9	2517	<b>410,00</b>
	8*	●	4	9,3	3020	<b>156,00</b>			4*	x	10	20,0	3020	<b>477,00</b>
									5*	x	10	22,7	3020	<b>507,00</b>
224	1	○	5	2,5	2012	<b>50,10</b>		6*	x	7	33,6	3535	<b>574,00</b>	
	2	○	5	3,2	2012	<b>58,50</b>								
	3	○	9	3,9	2012	<b>68,20</b>								
	4	○	9	5,2	2517	<b>80,40</b>								
	5	○	9	6,0	2517	<b>92,30</b>								
	6*	○	9	6,6	2517	<b>103,00</b>								
	8*	●	4	11,8	3020	<b>159,00</b>								
	250	1	x	7	2,8	2012	<b>55,30</b>							
2		x	7	3,5	2012	<b>65,80</b>								
3		x	10	4,3	2012	<b>78,70</b>								
4		x	10	5,7	2517	<b>95,80</b>								
5		x	10	6,4	2517	<b>112,00</b>								
6*		x	10	7,0	2517	<b>115,00</b>								
8*		x	10	10,5	3020	<b>182,00</b>								
280		1	x	7	2,9	2012	<b>70,30</b>							
	2	x	7	4,0	2012	<b>78,70</b>								
	3	x	7	5,3	2517	<b>90,00</b>								
	4	x	10	6,4	2517	<b>112,00</b>								
	5	x	10	7,1	2517	<b>132,00</b>								
	6*	x	10	7,8	2517	<b>137,00</b>								
	8*	x	10	10,8	3020	<b>212,00</b>								
	315	1	x	7	3,1	2012	<b>81,30</b>							
2		x	7	4,2	2012	<b>89,60</b>								
3		x	7	6,1	2517	<b>105,00</b>								
4		x	10	7,6	2517	<b>128,00</b>								
5		x	10	8,6	2517	<b>152,00</b>								
6*		x	10	9,3	2517	<b>236,00</b>								
355	1	x	7	3,5	2012	<b>119,00</b>								
	2	x	7	5,1	2012	<b>133,00</b>								
	3	x	7	7,3	2517	<b>168,00</b>								
	4	x	10	8,9	2517	<b>219,00</b>								
	5	x	10	10,0	2517	<b>247,00</b>								
	6*	x	10	10,7	2517	<b>324,00</b>								
	8*	x	10	16,0	3030	<b>467,00</b>								
	400	1	x	7	6,0	2012	<b>137,00</b>							
2		x	7	6,3	2517	<b>168,00</b>								
3		x	7	8,0	2517	<b>204,00</b>								
4		x	10	10,1	2517	<b>254,00</b>								
5		x	10	11,7	3020	<b>272,00</b>								
6*		x	10	14,5	3020	<b>379,00</b>								
8*		x	10	18,2	3030	<b>507,00</b>								
450		1	x	7	6,1	2517	<b>190,00</b>							
	2	x	7	8,2	2517	<b>219,00</b>								
	3	x	7	9,8	2517	<b>238,00</b>								
	4	x	10	11,8	3020	<b>274,00</b>								
	5	x	10	13,9	3020	<b>300,00</b>								
	6*	x	10	16,9	3030	<b>424,00</b>								
	8*	x	10	24,0	3535	<b>555,00</b>								

Anzahl der Rillen No. of grooves z	1	2	3	4	5	6	8
Kranzbreite Face width b <sub>2</sub> (mm)	16	28	40	52	64	76	100

Taper-Buchse Taper bush	2012	2517	3020	3030	3535
Bohrung d <sub>2</sub> (mm) von ... bis ... Bore d <sub>2</sub> (mm) from ... to ...	14-50	16-60	25-75	35-75	35-90
€/Stück each	<b>15,20</b>	<b>19,10</b>	<b>24,80</b>	<b>32,50</b>	<b>62,60</b>

- Vollscheibe *Solid pulley*
  - Bodenscheibe *Plate pulley*  
(mit oder ohne Spiegel *with or without holes*)
  - × Armscheibe *Spoked pulley*
- Material: EN-GJL 200 – DIN EN 1561  
 \* Keine Lagerware *Non stock items*

Bohrungsdurchmesser d<sub>2</sub> siehe Seite 3.  
 Bore diameters d<sub>2</sub> see page 3.

**Profil Section SPA/13**

Richt-durchmesser Datum diameter $d_2$ (mm)	Anzahl der Rillen No. of grooves	Ausführung Type		Gewicht ohne Buchse Weight without bush (= kg)	Taper-Buchse Taper bush	€ Stück ohne Buchse each without bush	Richt-durchmesser Datum diameter $d_2$ (mm)	Anzahl der Rillen No. of grooves	Ausführung Type		Gewicht ohne Buchse Weight without bush (= kg)	Taper-Buchse Taper bush	€ Stück ohne Buchse each without bush	
63▲	1	●	11	0,6	1108	25,30	140	1	●	8	1,8	1610	37,40	
	2	●	11	0,8	1108	26,90		2	●	2	2,0	2012	40,70	
67▲	1	●	8	0,3	1108	21,90		3	●	2	2,8	2517	50,10	
	2	●	6	0,5	1108	23,80		4	●	2	3,1	2517	58,50	
71▲	1	●	8	0,3	1108	22,50	150	5	●	2	3,4	2517	68,20	
	2	●	6	0,5	1108	24,70		1	●	8	1,4	1610	38,90	
	3	●	6	0,7	1108	30,90		2	●	2	2,4	2012	43,00	
75▲	1	●	8	0,4	1108	22,90		3	●	2	3,5	2517	53,20	
	2	●	6	0,6	1108	26,30		4	●	2	3,8	2517	60,60	
	3	●	6	0,8	1108	43,10		5	●	2	4,2	2517	69,00	
80▲	1	●	8	0,5	1210	22,90	160	1	○	5	1,9	1610	40,00	
	2	●	6	0,6	1210	26,00		2	●	2	2,9	2012	44,00	
	3	●	6	0,9	1210	33,20		3	●	2	3,9	2517	54,50	
85	1	●	8	0,6	1210	23,50		4	●	2	4,4	2517	62,80	
	2	●	6	0,7	1210	27,30		5	●	2	5,1	2517	72,00	
	3	●	6	1,0	1210	34,50		170	1	○	5	2,0	1610	47,50
90	1	●	8	0,7	1210	24,30	2		●	2	3,1	2012	59,70	
	2	●	6	0,7	1610	27,70	3		●	2	4,6	2517	71,70	
	3	●	6	1,0	1610	35,80	4	●	2	5,5	2517	81,60		
95	4	●	6	1,2	1615	43,00		5	●	2	5,9	3020	90,00	
	1	●	8	0,8	1210	25,70		180	1	○	5	2,1	1610	44,00
	2	●	6	0,9	1610	29,10			2	○	9	3,4	2012	51,00
3	●	6	1,1	1610	37,60	3	●		2	5,1	2517	59,30		
100	4	●	6	1,4	1615	43,60		4	●	2	5,9	2517	67,20	
	1	●	8	0,8	1610	27,10		5	●	2	6,2	3020	78,10	
	2	●	6	0,9	1610	31,20		190	1	○	5	2,3	1610	59,70
3	●	2	1,2	1610	38,90	2	○		9	3,8	2012	72,50		
4	●	2	1,7	1610	47,50	3	●		2	5,4	2517	85,10		
106	5	●	6	1,9	1610	55,80		4	●	2	6,8	2517	98,30	
	1	●	8	0,9	1610	28,90		5	●	2	7,4	3020	108,00	
	2	●	6	1,1	1610	32,50		200	1	○	5	2,6	2012	48,80
3	●	2	1,4	1610	40,70	2	○		5	4,1	2517	56,70		
4	●	6	2,0	2012	48,30	3	○		9	4,9	2517	64,10		
112	5	●	6	2,0	2012	57,40		4	●	2	7,4	3020	71,70	
	1	●	8	1,0	1610	30,50		5	●	4	8,4	3020	83,00	
	2	●	6	1,2	1610	34,50		212	1	○	5	2,7	2012	53,90
3	●	6	1,3	2012	42,30	2	○		5	4,3	2517	61,50		
4	●	6	1,9	2012	49,70	3	○		9	5,2	2517	70,30		
118	5	●	6	2,1	2012	60,20		4	●	2	7,3	3020	82,20	
	1	●	8	1,2	1610	32,10		5	●	2	8,2	3020	94,00	
	2	●	6	1,4	1610	35,80		224	1	x	7	2,7	2012	58,80
3	●	2	1,8	2012	43,60	2	○		5	4,4	2517	65,80		
4	●	2	2,0	2012	52,30	3	○		9	5,5	2517	76,00		
125	5	●	2	2,4	2012	62,80		4	●	2	7,4	3020	92,30	
	1	●	8	1,4	1610	33,70		5	●	2	8,3	3020	105,00	
	2	●	2	1,7	1610	37,60		236	1	x	7	2,8	2012	63,30
3	●	2	2,0	2012	45,70	2	○		5	4,6	2517	72,50		
4	●	2	2,5	2012	53,90	3	○		9	5,7	2517	84,30		
132	5	●	2	2,7	2012	64,10		4	●	2	7,8	3020	102,00	
	1	●	8	1,6	1610	35,00		5	●	2	8,7	3020	116,00	
	2	●	2	1,8	2012	39,60		250	1	x	7	2,9	2012	65,80
3	●	2	2,3	2012	47,50	2	x		7	4,8	2517	76,00		
4	●	2	2,6	2517	55,30	3	○		9	5,9	2517	89,60		
	5	●	2	2,9	2517	65,00								

▲ nur für Profil 13 only for section 13

Anzahl der Rillen No. of grooves z	1	2	3	4	5
Kranzbreite Face width $b_2$ (mm)	20	35	50	65	80

Taper-Buchse Taper bush	1108	1210	1610	1615	2012	2517	3020	3535
Bohrung $d_2$ (mm) von ... bis ... Bore $d_2$ (mm) from ... to ...	10-28	11-32	14-42	14-42	14-50	16-60	25-75	35-90
€/Stück each	7,90	10,40	12,40	13,00	15,20	19,10	24,80	62,60

- Vollscheibe Solid pulley
  - Bodenscheibe Plate pulley (mit oder ohne Spiegel with or without holes)
  - × Armscheibe Spoked pulley
- Material: EN-GJL 200 – DIN EN 1561

Bohrungsdurchmesser  $d_2$  siehe Seite 3.  
 Bore diameters  $d_2$  see page 3.

**Profil Section SPA/13**

Richt- durchmesser Datum diameter d <sub>2</sub> (mm)	Anzahl der Rillen No. of grooves	Ausführung Type		Gewicht ohne Buchse Weight without bush (= kg)	Taper- Buchse Taper bush	€ Stück ohne Buchse each without bush	Richt- durchmesser Datum diameter d <sub>2</sub> (mm)	Anzahl der Rillen No. of grooves	Ausführung Type		Gewicht ohne Buchse Weight without bush (= kg)	Taper- Buchse Taper bush	€ Stück ohne Buchse each without bush
280	1	x	7	3,3	2012	<b>81,30</b>	450	1	x	7	7,0	2012	<b>149,00</b>
	2	x	7	5,4	2517	<b>90,00</b>		2	x	7	10,3	2517	<b>172,00</b>
	3	O	9	6,7	2517	<b>104,00</b>		3	x	7	14,1	3020	<b>212,00</b>
	4	O	9	8,8	3020	<b>128,00</b>		4	x	10	15,5	3020	<b>252,00</b>
	5	O	5	15,5	3535	<b>149,00</b>		5	x	7	24,3	3535	<b>305,00</b>
315	1	x	7	3,6	2012	<b>93,10</b>	500	1	x	7	8,0	2517	<b>166,00</b>
	2	x	7	6,0	2517	<b>102,00</b>		2	x	7	11,6	2517	<b>187,00</b>
	3	O	5	8,3	3020	<b>121,00</b>		3	x	7	16,0	3020	<b>247,00</b>
	4	O	9	9,7	3020	<b>148,00</b>		4	x	10	18,2	3020	<b>287,00</b>
	5	O	5	17,0	3535	<b>173,00</b>		5	x	7	27,3	3535	<b>349,00</b>
355	1	x	7	4,2	2012	<b>110,00</b>	560	1	x	7	11,6	2517	<b>200,00</b>
	2	x	7	6,7	2517	<b>122,00</b>		2	x	7	15,5	3020	<b>247,00</b>
	3	x	7	9,2	3020	<b>148,00</b>		3	x	7	17,8	3020	<b>278,00</b>
	4	x	10	11,0	3020	<b>177,00</b>		4	x	7	26,7	3535	<b>325,00</b>
	5	x	7	18,6	3535	<b>208,00</b>		5	x	7	30,4	3535	<b>395,00</b>
400	1	x	7	4,9	2012	<b>131,00</b>	630	1	x	7	10,1	2517	<b>198,00</b>
	2	x	7	8,1	2517	<b>143,00</b>		2	x	7	16,0	3020	<b>297,00</b>
	3	x	7	11,0	3020	<b>178,00</b>		3	x	7	22,0	3020	<b>316,00</b>
	4	x	10	12,8	3020	<b>210,00</b>		4	x	7	30,8	3535	<b>379,00</b>
	5	x	7	21,0	3535	<b>249,00</b>		5	x	7	33,7	3535	<b>484,00</b>

Anzahl der Rillen No. of grooves z	1	2	3	4	5
Kranzbreite Face width b <sub>2</sub> (mm)	20	35	50	65	80

Taper-Buchse Taper bush	2012	2517	3020	3535
Bohrung d <sub>2</sub> (mm) von ... bis ... Bore d <sub>2</sub> (mm) from ... to ...	14-50	16-60	25-75	35-90
€/Stück each	<b>15,20</b>	<b>19,10</b>	<b>24,80</b>	<b>62,60</b>

- Vollscheibe Solid pulley
- O Bodenscheibe Plate pulley  
(mit oder ohne Spiegel with or without holes)
- × Armscheibe Spoked pulley

Material: EN-GJL 200 – DIN EN 1561

Bohrungsdurchmesser d<sub>2</sub> siehe Seite 3.  
 Bore diameters d<sub>2</sub> see page 3.



**Profil Section SPB/17**

Richt- durchmesser Datum diameter d <sub>d</sub> (mm)	Anzahl der Rillen No. of grooves	Ausführung Type		Gewicht ohne Buchse Weight without bush (= kg)	Taper- Buchse Taper bush	€ Stück ohne Buchse each without bush	Richt- durchmesser Datum diameter d <sub>d</sub> (mm)	Anzahl der Rillen No. of grooves	Ausführung Type		Gewicht ohne Buchse Weight without bush (= kg)	Taper- Buchse Taper bush	€ Stück ohne Buchse each without bush	
100▲	1	●	1	0,9	1610	<b>38,90</b>	200	1	●	8	5,0	2012	<b>58,80</b>	
	2	●	6	1,2	1610	<b>41,50</b>		2	●	8	5,4	2517	<b>70,70</b>	
	3	●	6	1,7	1610	<b>48,30</b>		3	●	2	6,5	2517	<b>77,30</b>	
112▲	1	●	1	1,1	1610	<b>39,70</b>		4	●	2	8,8	3020	<b>89,60</b>	
	2	●	6	1,5	1610	<b>43,00</b>		5	●	2	9,1	3020	<b>101,00</b>	
	3	●	6	2,0	1610	<b>49,20</b>		6	●	4	10,3	3020	<b>113,00</b>	
								8	●	4	13,5	3535	<b>209,00</b>	
118▲	1	●	1	1,3	1610	<b>40,70</b>	212	1	●	8	4,2	2012	<b>64,10</b>	
	2	●	6	1,7	1610	<b>43,80</b>		2	●	8	4,9	2517	<b>77,30</b>	
	3	●	6	2,3	1610	<b>50,50</b>		3	●	2	6,0	2517	<b>83,90</b>	
125▲	1	●	1	1,5	1610	<b>41,50</b>		4	●	2	9,8	3020	<b>95,30</b>	
	2	●	2	1,9	2012	<b>44,80</b>		5	●	2	11,0	3020	<b>105,00</b>	
	3	●	2	2,4	2012	<b>52,30</b>		6	●	4	14,3	3535	<b>132,00</b>	
	4	●	4	3,0	2012	<b>59,70</b>		8	●	4	16,6	3535	<b>231,00</b>	
	5	●	6	3,5	2012	<b>70,30</b>								
132▲	1	●	1	1,8	1610	<b>44,40</b>	224	1	●	8	4,7	2012	<b>69,00</b>	
	2	●	2	2,2	2012	<b>48,80</b>		2	●	8	5,3	2517	<b>79,90</b>	
	3	●	2	2,8	2012	<b>57,10</b>		3	●	2	6,3	2517	<b>92,30</b>	
	4	●	4	3,4	2012	<b>67,20</b>		4	●	2	11,3	3020	<b>110,00</b>	
	5	●	4	3,7	2012	<b>78,10</b>		5	●	2	12,7	3020	<b>126,00</b>	
140	1	●	1	2,3	1610	<b>44,80</b>		6	●	4	17,0	3535	<b>152,00</b>	
	2	●	2	2,7	2012	<b>49,20</b>		8	●	4	19,3	3535	<b>249,00</b>	
	3	●	2	3,3	2012	<b>60,60</b>		10	●	4	21,8	3535	<b>314,00</b>	
	4	●	2	3,7	2517	<b>69,30</b>		236	1	●	8	5,0	2012	<b>71,70</b>
	5	●	2	4,5	2517	<b>80,80</b>			2	●	8	5,5	2517	<b>83,90</b>
	6	●	4	4,6	2517	<b>92,70</b>			3	x	10	7,0	2517	<b>100,00</b>
150	1	●	1	2,7	1610	<b>47,50</b>		4	x	10	14,5	3020	<b>121,00</b>	
	2	●	2	3,1	2012	<b>51,40</b>		5	●	6	16,9	3535	<b>139,00</b>	
	3	●	2	3,9	2517	<b>63,70</b>		6	●	4	20,0	3535	<b>165,00</b>	
	4	●	2	4,4	2517	<b>71,70</b>		8	●	4	22,3	3535	<b>261,00</b>	
	5	●	4	5,2	2517	<b>83,00</b>		10	●	4	25,3	3535	<b>330,00</b>	
	6	●	4	5,6	2517	<b>94,50</b>		250	1	●	8	5,4	2012	<b>73,80</b>
160	1	●	1	2,5	1610	<b>48,80</b>	2		x	7	5,5	2517	<b>91,30</b>	
	2	●	2	2,9	2012	<b>53,90</b>	3		●	2	7,7	3020	<b>108,00</b>	
	3	●	2	4,2	2517	<b>66,80</b>	4	●	2	19,6	3020	<b>125,00</b>		
	4	●	4	4,9	2517	<b>75,50</b>	5	●	4	21,7	3535	<b>151,00</b>		
	5	●	4	6,0	2517	<b>86,10</b>	6	●	4	23,3	3535	<b>176,00</b>		
	6	●	4	5,4	3020	<b>98,00</b>	8	●	4	27,5	3535	<b>264,00</b>		
170	1	●	1	2,9	1610	<b>51,00</b>	265	10	●	4	29,3	3535	<b>344,00</b>	
	2	●	2	3,3	2012	<b>58,80</b>		2	●	7	6,2	2517	<b>218,00</b>	
	3	●	2	4,9	2517	<b>68,50</b>		3	○	9	8,0	3020	<b>331,00</b>	
	4	●	4	5,7	2517	<b>78,10</b>		4	○	9	9,5	3020	<b>416,00</b>	
	5	●	4	6,1	3020	<b>89,20</b>		6	○	9	16,7	3525	<b>523,00</b>	
	6	●	4	6,5	3020	<b>101,00</b>		8	○	9	24,0	3525	<b>714,00</b>	
180	1	●	1	4,1	1610	<b>53,90</b>	280	1	x	7	6,1	2012	<b>103,00</b>	
	2	●	8	4,5	2517	<b>64,10</b>		2	x	7	6,8	2517	<b>108,00</b>	
	3	●	2	5,5	2517	<b>73,40</b>		3	x	10	8,6	3020	<b>124,00</b>	
	4	●	4	6,9	2517	<b>80,80</b>		4	○	9	10,1	3020	<b>153,00</b>	
	5	●	4	7,1	3020	<b>92,70</b>		5	○	9	17,8	3535	<b>177,00</b>	
	6	●	4	7,7	3020	<b>104,00</b>		6	○	9	19,6	3535	<b>203,00</b>	
	8	●	4	9,5	3020	<b>193,00</b>		8	○	9	26,7	3535	<b>289,00</b>	
								10	○	9	30,5	3535	<b>380,00</b>	
190	1	●	8	4,6	2012	<b>56,20</b>	300	2	x	7	7,3	2517	<b>116,00</b>	
	2	●	8	5,0	2517	<b>68,20</b>		3	x	10	9,2	3020	<b>132,00</b>	
	3	●	2	6,3	2517	<b>76,90</b>		4	○	9	14,3	3020	<b>152,00</b>	
	4	●	4	7,6	2517	<b>85,70</b>		5	○	9	18,2	3535	<b>170,00</b>	
	5	●	4	8,1	3020	<b>96,20</b>		6	○	9	21,9	3535	<b>209,00</b>	
	6	●	4	9,2	3020	<b>108,00</b>		8	○	9	26,2	3535	<b>328,00</b>	
	8	●	4	11,2	3030	<b>202,00</b>								

▲ nur für Profil 17 only for section 17

Anzahl der Rillen No. of grooves z	1	2	3	4	5	6	8	10
Kranzbreite Face width b <sub>2</sub> (mm)	25	44	63	82	101	120	158	196

Taper-Buchse Taper bush	1610	2012	2517	3020	3030	3535
Bohrung d <sub>2</sub> (mm) von ... bis ... Bore d <sub>2</sub> (mm) from ... to ...	14-42	14-50	16-60	25-75	35-75	35-90
€/Stück each	<b>12,40</b>	<b>15,20</b>	<b>19,10</b>	<b>24,80</b>	<b>32,50</b>	<b>62,60</b>

- Vollscheibe Solid pulley
- Bodenscheibe Plate pulley  
(mit oder ohne Spiegel with or without holes)
- × Armscheibe Spoked pulley

Material: EN-GJL 200 – DIN EN 1561

Bohrungsdurchmesser d<sub>2</sub> siehe Seite 3.  
Bore diameters d<sub>2</sub> see page 3.

**Profil Section SPB/17**

Richt- durchmesser Datum diameter d <sub>d</sub> (mm)	Anzahl der Rillen No. of grooves	Ausführung Type		Gewicht ohne Buchse Weight without bush (= kg)	Taper- Buchse Taper bush	€ Stück ohne Buchse each without bush	Richt- durchmesser Datum diameter d <sub>d</sub> (mm)	Anzahl der Rillen No. of grooves	Ausführung Type		Gewicht ohne Buchse Weight without bush (= kg)	Taper- Buchse Taper bush	€ Stück ohne Buchse each without bush		
315	1	x	7	7,2	2012	119,00	560	2	x	7	16,5	3030	263,00		
	2	x	7	7,8	2517	123,00		3	x	7	25,9	3235	334,00		
	3	x	10	9,6	3020	143,00		4	x	7	29,0	3535	387,00		
	4	O	5	17,1	3535	176,00		5	x	7	35,3	4040	476,00		
	5	O	9	18,8	3535	207,00		6	x	10	43,1	4040	550,00		
	6	O	9	23,0	3535	255,00		8	x	10	49,0	4545	779,00		
	8	O	9	26,0	3535	327,00		10*	x	10	55,7	4545	892,00		
	10	O	9	31,5	3535	428,00		630	2	x	7	18,5	3020	349,00	
	335	2	x	7	7,8	2517			134,00	3	x	7	28,9	3535	379,00
		3	x	10	10,5	3020			158,00	4	x	7	33,3	3535	455,00
4		x	7	18,3	3535	183,00	5		x	7	43,1	4040	546,00		
5		x	10	19,5	3535	214,00	6		x	10	49,2	4040	640,00		
6		x	10	22,0	3535	280,00	8		x	10	62,0	4545	892,00		
8		x	10	28,2	3535	374,00	10*		x	10	72,0	4545	1.028,00		
10*		x	10	36,0	4040	454,00	710		3	x	7	33,2	3535	445,00	
355		2	x	7	8,7	3020			146,00	4	x	7	39,1	3535	525,00
		3	x	10	10,8	3020			176,00	5	x	7	50,2	4040	665,00
		4	x	7	18,6	3535		210,00	6	x	10	62,3	4545	756,00	
	5	x	10	20,8	3535	249,00		8	x	10	71,0	4545	997,00		
	6	O	9	22,8	3535	297,00		10*	x	10	80,0	4545	1.186,00		
	8	x	10	27,0	3535	384,00		800	3	x	7	36,7	3535	616,00	
	10*	x	10	38,0	4040	491,00			4	x	7	48,8	4040	700,00	
	375	2	x	7	9,5	3020			326,00	5	x	7	56,1	4040	865,00
		3	x	10	11,5	3020			433,00	6	x	10	71,4	4545	963,00
		4	x	10	16,5	3525	528,00		8	x	10	90,9	4545	1.213,00	
6		x	10	25,0	3535	687,00	10*		x	10	102,0	4545	1.399,00		
8		x	10	28,0	4040	884,00	900		3	x	7	46,8	3535	853,00	
400		2	x	7	10,0	3020			174,00	4	x	7	60,0	4040	934,00
		3	x	7	18,3	3535			214,00	5	x	7	74,8	4545	1.019,00
		4	x	7	20,5	3535			254,00	6	x	10	81,5	4545	1.310,00
		5	x	10	23,4	3535		299,00	8	x	10	110,0	4545	1.490,00	
		6	x	10	25,1	3535		352,00	10*	x	10	126,0	5050	1.824,00	
	8	x	10	36,5	4040	460,00		1000	3	x	7	56,5	4040	1.135,00	
	10*	x	10	41,0	4040	597,00			4	x	7	66,5	4040	1.183,00	
	425	2	x	7	11,5	3020			368,00	5	x	7	80,5	4545	1.328,00
		3	x	7	18,0	3535			502,00	6	x	10	90,0	4545	1.569,00
		4	x	7	19,5	3535	600,00		8	x	10	132,0	5050	1.883,00	
6		x	10	25,1	4040	887,00	10*		x	10	147,0	5050	2.220,00		
8		x	10	52,5	4545	1.086,00	450								
450		2	x	7	12,1	3020									202,00
		3	x	7	21,9	3535									256,00
		4	x	7	24,5	3535									304,00
		5	x	10	27,3	3535		365,00							
		6	x	10	35,5	4040		424,00							
	8	x	10	40,9	4040	583,00									
	10*	x	10	53,5	4545	688,00									
	500	2	x	7	13,2	3020		227,00							
		3	x	7	23,1	3535		295,00							
		4	x	7	26,6	3535	342,00								
5		x	10	29,9	3535	419,00									
6		x	10	38,9	4040	483,00									
8		x	10	45,5	4040	683,00									
10*		x	10	61,0	4545	779,00									

Anzahl der Rillen No. of grooves z	1	2	3	4	5	6	8	10
Kranzbreite Face width b <sub>2</sub> (mm)	25	44	63	82	101	120	158	196

Taper-Buchse Taper bush	2012	2517	3020	3030	3535	4040	4545	5050
Bohrung d <sub>2</sub> (mm) von ... bis ... Bore d <sub>2</sub> (mm) from ... to ...	14-50	16-60	25-75	35-75	35-90	40-100	55-110	70-125
€/Stück each	15,20	19,10	24,80	32,50	62,60	88,00	112,00	179,00

- Vollscheibe Solid pulley
  - O Bodenscheibe Plate pulley  
(mit oder ohne Spiegel with or without holes)
  - × Armscheibe Spoked pulley
- Material: EN-GJL 200 – DIN EN 1561  
 \* Keine Lagerware Non stock items

Bohrungsdurchmesser d<sub>2</sub> siehe Seite 3.  
 Bore diameters d<sub>2</sub> see page 3.

**Profil Section SPC/22**

Richt- durchmesser Datum diameter d <sub>d</sub> (mm)	Anzahl der Rillen No. of grooves	Ausführung Type		Gewicht ohne Buchse Weight without bush (= kg)	Taper- Buchse Taper bush	€ Stück ohne Buchse each without bush	Richt- durchmesser Datum diameter d <sub>d</sub> (mm)	Anzahl der Rillen No. of grooves	Ausführung Type		Gewicht ohne Buchse Weight without bush (= kg)	Taper- Buchse Taper bush	€ Stück ohne Buchse each without bush	
200▲	3	●	4	9,0	2517	170,00	355	3	O	5	22,9	3535	334,00	
	4	●	4	10,5	3020	188,00		4	O	9	28,3	3535	378,00	
	5	●	4	14,0	3535	230,00		5	O	9	32,5	3535	431,00	
	6	●	4	17,0	3535	258,00		6	O	9	36,0	3535	501,00	
212▲	3	●	4	10,0	3020	188,00		8	O	9	67,5	4040	658,00	
	4	●	4	12,5	3020	211,00		10*	O	9	121,0	4545	808,00	
	5	●	4	15,0	3535	254,00		375	3	O	5	23,8	3535	362,00
	6	●	4	18,0	3535	283,00			4	O	9	30,0	3535	421,00
224	2	●	4	8,1	3020	205,00			5	O	9	33,0	3535	475,00
	3	●	4	11,0	3020	214,00			6	O	9	45,5	4040	558,00
	4	●	4	14,0	3535	240,00	8		O	9	68,0	4545	719,00	
	5	●	4	16,2	3535	289,00	400		3	x	7	24,1	3535	418,00
6	●	4	19,0	3535	322,00	4			x	10	28,0	3535	470,00	
8	●	4	24,9	3535	396,00	5			x	10	34,0	3535	510,00	
236	3	●	4	12,0	3020	243,00			6	O	9	48,0	4040	598,00
	4	●	4	17,2	3535	292,00			8	O	9	65,0	4545	737,00
	5	●	4	19,1	3535	316,00		10*	O	9	88,0	5050	901,00	
	6	●	4	20,8	3535	357,00		425	3	x	7	26,0	3535	439,00
8	●	4	25,5	3535	421,00	4			x	10	31,0	3535	495,00	
250	2	●	4	9,8	3020	236,00			5	O	9	45,0	4040	542,00
	3	●	4	14,5	3020	245,00			6	O	9	58,0	4545	642,00
	4	●	4	20,7	3535	274,00	8		O	9	74,0	4545	816,00	
	5	●	4	22,8	3535	306,00	450		3	x	7	28,6	3535	472,00
6	●	4	26,0	3535	350,00	4			x	10	33,5	3535	541,00	
8	●	4	29,7	3535	456,00	5			x	10	45,0	4040	605,00	
10*	●	4	34,0	4040	612,00	6			O	9	61,1	4545	668,00	
265	3	●	8	21,2	3535	262,00			8	O	9	78,7	5050	841,00
	4	O	9	24,0	3535	316,00		10*	O	9	101,0	5050	945,00	
	5	O	9	26,2	3535	352,00		475	3	x	7	40,0	3535	494,00
	6	O	9	29,0	3535	396,00			4	x	10	47,0	3535	549,00
8	O	9	33,3	3535	485,00	5			x	10	47,2	4040	616,00	
280	3	●	8	24,0	3535	275,00			6	O	9	62,8	4545	704,00
	4	O	9	29,0	3535	309,00	8		O	9	81,5	5050	898,00	
	5	O	9	31,0	3535	358,00	500		3	x	7	30,9	3535	508,00
	6	O	9	33,8	3535	407,00			4	x	10	39,0	3535	574,00
8	O	9	37,5	3535	507,00	5			x	10	48,7	4040	684,00	
10*	O	9	45,0	4040	660,00	6			x	10	60,2	4545	752,00	
300	3	O	5	21,0	3535	306,00			8	O	9	87,4	5050	982,00
	4	O	9	25,0	3535	340,00		10*	O	9	127,0	5050	1.124,00	
	5	O	9	28,5	3535	386,00		560	3	x	7	36,0	3535	668,00
	6	O	9	29,0	3535	423,00			4	x	10	50,0	4040	685,00
8	●	4	46,5	4040	568,00	5			x	10	63,0	4545	756,00	
10*	O	9	53,5	4545	697,00	6			x	10	77,0	5050	833,00	
315	3	O	5	21,6	3535	306,00	8		x	10	94,0	5050	1.076,00	
	4	O	9	24,6	3535	337,00	10*		O	9	115,0	5050	1.208,00	
	5	O	9	29,0	3535	378,00	630		3	x	7	48,5	4040	719,00
	6	O	9	31,4	3535	441,00			4	x	7	61,0	4545	783,00
8	●	4	50,0	4040	609,00	5			x	10	77,0	5050	868,00	
10*	O	9	58,0	4545	735,00	6			x	10	86,0	5050	973,00	
335	3	O	5	22,5	3535	323,00		8	x	10	105,5	5050	1.185,00	
	4	O	9	26,5	3535	377,00		10*	O	9	130,0	5050	1.398,00	
	5	O	9	30,0	3535	428,00		710	3	x	7	62,5	4040	991,00
	6	O	9	35,0	3535	493,00			4	x	7	78,6	4545	1.030,00
8	O	9	58,0	4040	648,00	5			x	10	89,6	5050	1.032,00	
						6			x	10	99,4	5050	1.160,00	
						8	x		10	117,5	5050	1.419,00		
						10*	O		9	137,1	5050	1.649,00		

▲ nur für Profil 22 only for section 22

Anzahl der Rillen No. of grooves z	2	3	4	5	6	8	10
Kranzbreite Face width b <sub>2</sub> (mm)	59,5	85	110,5	136	161,5	212,5	263,5

Taper-Buchse Taper bush	2517	3020	3535	4040	4545	5050
Bohrung d <sub>2</sub> (mm) von ... bis ... Bore d <sub>2</sub> (mm) from ... to ...	16-60	25-75	35-90	40-100	55-110	70-125
€/Stück each	19,10	24,80	62,60	88,00	112,00	179,00

- Vollscheibe Solid pulley
  - O Bodenscheibe Plate pulley  
(mit oder ohne Spiegel with or without holes)
  - × Armscheibe Spoked pulley
- Material: EN-GJL 200 – DIN EN 1561  
 \* Keine Lagerware Non stock items

Bohrungsdurchmesser d<sub>2</sub> siehe Seite 3.  
 Bore diameters d<sub>2</sub> see page 3.

**Profil Section SPC/22**

Richt- durchmesser Datum diameter d <sub>d</sub> (mm)	Anzahl der Rillen No. of grooves	Ausführung Type		Gewicht ohne Buchse Weight without bush (= kg)	Taper- Buchse Taper bush	€ Stück ohne Buchse each without bush	Richt- durchmesser Datum diameter d <sub>d</sub> (mm)	Anzahl der Rillen No. of grooves	Ausführung Type		Gewicht ohne Buchse Weight without bush (= kg)	Taper- Buchse Taper bush	€ Stück ohne Buchse each without bush	
800	3	x	7	72,0	4545	<b>1.035,00</b>	1250	5	x	10	177,6	5050	<b>2.103,00</b>	
	4	x	7	90,8	5050	<b>1.042,00</b>		6	x	10	201,4	5050		<b>2.363,00</b>
	5	x	10	102,5	5050	<b>1.186,00</b>		8	x	10	243,7	5050		<b>2.920,00</b>
	6	x	10	113,7	5050	<b>1.266,00</b>		10*	O	9	292,1	5050		<b>3.423,00</b>
	8	x	10	136,6	5050	<b>1.525,00</b>								
	10*	O	9	160,7	5050	<b>1.851,00</b>								
1000	5	x	10	134,0	5050	<b>1.554,00</b>								
	6	x	10	150,0	5050	<b>1.765,00</b>								
	8	x	10	181,4	5050	<b>2.272,00</b>								
	10*	O	9	217,2	5050	<b>2.582,00</b>								

Anzahl der Rillen No. of grooves z	3	4	5	6	8	10
Kranzbreite Face width b <sub>2</sub> (mm)	85	110,5	136	161,5	212,5	263,5

Taper-Buchse Taper bush	4545	5050
Bohrung d <sub>2</sub> (mm) von ... bis ... Bore d <sub>2</sub> (mm) from ... to ...	55-110	70-125
€/Stück each	<b>112,00</b>	<b>179,00</b>

- Vollscheibe *Solid pulley*
  - O Bodenscheibe *Plate pulley*  
(mit oder ohne Spiegel *with or without holes*)
  - × Armscheibe *Spoked pulley*
- Material: EN-GJL 200 – DIN EN 1561  
 \* Keine Lagerware *Non stock items*

Bohrungsdurchmesser d<sub>2</sub> siehe Seite 3.  
 Bore diameters d<sub>2</sub> see page 3.

**Profil Section SPZ/10**

Richt- durchmesser Datum d <sub>g</sub> (mm)	Anzahl der Rillen No. of grooves	Aus- führung Type	Gewicht Weight (≈ kg)	Fertig- bohrung Finished bore d <sub>max</sub> (mm)	Naben- länge Hub length l (mm)	€ Stück zentriert each centered	Richt- durchmesser Datum d <sub>g</sub> (mm)	Anzahl der Rillen No. of grooves	Aus- führung Type	Gewicht Weight (≈ kg)	Fertig- bohrung Finished bore d <sub>max</sub> (mm)	Naben- länge Hub length l (mm)	€ Stück zentriert each centered
45▲	1	O	0,2	16	24	8,10	170	1	x	1,7	40	30	24,00
	2	O	0,3	16	35	12,10		2	x	1,9	40	38	35,40
	3	O	0,4	16	35	15,20		3	x	3,0	42	40	48,20
50▲	1	O	0,3	20	24	8,80	180	1	x	2,1	32	30	26,40
	2	O	0,4	20	35	12,10		2	x	3,1	38	38	38,50
	3	O	0,5	20	40	16,90		3	x	3,5	42	40	49,80
56▲	1	O	0,3	20	24	8,80	190	1	x	2,3	35	30	28,90
	2	O	0,5	25	35	12,10		2	x	2,4	35	38	40,10
	3	O	0,7	25	40	16,90		3	x	4,0	35	40	53,00
63	1	O	0,3	25	24	8,80	200	1	x	2,4	32	38	30,60
	2	O	0,6	25	35	12,10		2	x	2,9	38	38	42,60
	3	O	0,9	25	40	17,60		3	x	4,5	42	40	54,60
71	1	O	0,3	25	24	8,80	212	1	x	2,6	35	30	36,10
	2	O	0,6	25	35	12,80		2	x	3,4	35	38	45,80
	3	O	1,0	30	40	18,50		3	x	5,0	38	40	59,40
75	1	O	0,4	24	24	8,80	225	1	x	2,8	32	38	38,50
	2	O	0,6	24	35	13,70		2	x	4,0	38	38	50,60
	3	O	1,1	28	40	20,90		3	x	5,3	42	40	64,20
80	1	O	0,4	25	24	8,80	250	1	x	3,3	32	38	41,80
	2	O	0,7	30	35	14,40		2	x	4,8	38	38	57,00
	3	O	1,1	38	35	21,80		3	x	6,0	42	40	74,60
85	1	O	0,3	25	24	9,70	280	1	x	3,9	35	34	53,00
	2	O	0,7	30	35	16,90		2	x	5,2	42	38	69,10
	3	O	1,1	38	35	23,40		3	x	7,0	48	40	88,30
90	1	O	0,4	25	24	9,70	315	1	x	4,4	35	34	63,40
	2	O	0,8	30	35	17,60		2	x	6,8	42	38	79,50
	3	O	1,2	38	38	24,00		3	x	8,3	48	40	94,70
95	1	O	0,4	28	24	11,30	355	1	x	4,6	35	34	77,10
	2	O	0,8	28	35	18,50		2	x	8,0	42	40	92,30
	3	O	1,2	38	38	25,70		3	x	10,0	48	45	112,00
100	1	O	0,5	28	24	12,10							
	2	O	0,9	30	35	18,50							
	3	O	1,3	38	38	27,30							
106	1	O	0,5	30	24	12,80							
	2	O	1,0	28	35	20,90							
	3	O	1,3	38	38	28,90							
112	1	O	0,5	28	24	13,70							
	2	O	1,0	30	35	22,50							
	3	O	1,4	38	38	30,60							
118	1	O	0,6	28	24	14,40							
	2	O	1,1	38	35	24,00							
	3	O	1,5	38	38	32,20							
125	1	O	0,7	28	24	15,20							
	2	O	1,2	38	35	25,70							
	3	O	1,6	38	40	33,70							
132	1	O	0,8	30	24	17,60							
	2	O	1,3	38	35	26,40							
	3	O	1,6	40	40	35,40							
140	1	O	0,9	28	24	18,50							
	2	O	1,4	38	38	28,90							
	3	O	1,7	38	40	36,10							
150	1	x	1,1	28	24	20,90							
	2	O	1,5	38	38	30,60							
	3	O	1,9	38	40	43,30							
160	1	x	1,2	32	30	23,40							
	2	x	1,6	38	38	33,00							
	3	x	2,4	42	40	48,20							
<b>▲ nur für Profil 10 only for section 10</b>													

Anzahl der Rillen No. of grooves z	1	2	3
Kranzbreite Face width b <sub>2</sub> (mm)	16	28	40

- Vollscheibe Solid pulley
  - O Bodenscheibe Plate pulley (mit oder ohne Spiegel with or without holes)
  - x Armscheibe Spoked pulley
- Nabenlage: einseitig bündig Hub position: one side flush  
 Material: EN-GJL 200 – DIN EN 1561

**Profil Section SPA/13**

Richt- durchmesser Datum d <sub>d</sub> (mm)	Anzahl der Rillen No. of grooves	Aus- führung Type	Gewicht Weight (≈ kg)	Fertig- bohrung Finished bore d <sub>max</sub> (mm)	Naben- länge Hub length l (mm)	€ Stück zentriert each centered	Richt- durchmesser Datum d <sub>d</sub> (mm)	Anzahl der Rillen No. of grooves	Aus- führung Type	Gewicht Weight (≈ kg)	Fertig- bohrung Finished bore d <sub>max</sub> (mm)	Naben- länge Hub length l (mm)	€ Stück zentriert each centered
50▲	1	O	0,3	18	34	<b>8,80</b>	125	1	O	1,4	32	34	<b>18,50</b>
	2	O	0,5	18	49	<b>12,80</b>		2	O	1,9	38	49	<b>26,40</b>
	3	O	0,6	18	47	<b>18,50</b>		3	O	2,6	42	42	<b>34,50</b>
56▲	1	O	0,4	20	34	<b>8,80</b>	132	4 <sup>v</sup>	O	3,5	42	53	<b>45,80</b>
	2	O	0,6	20	49	<b>14,40</b>		5 <sup>v</sup>	O	4,4	48	65	<b>54,60</b>
	3	O	0,7	20	47	<b>19,30</b>		1	O	1,5	32	34	<b>19,30</b>
63▲	1	O	0,5	25	34	<b>8,80</b>	140	2	O	2,2	38	49	<b>28,90</b>
	2	O	0,8	25	49	<b>14,40</b>		3	O	2,6	42	42	<b>38,50</b>
	3	O	0,9	25	47	<b>19,30</b>		4 <sup>v</sup>	O	3,6	42	53	<b>47,30</b>
	4 <sup>v</sup>	O	1,2	25	60	<b>25,70</b>		5 <sup>v</sup>	O	4,8	48	65	<b>57,00</b>
	5 <sup>v</sup>	O	1,5	25	70	<b>33,00</b>		1	O	1,5	32	34	<b>21,80</b>
71▲	1	O	0,5	25	34	<b>8,80</b>	150	2	O	2,3	38	49	<b>30,60</b>
	2	O	0,9	28	49	<b>16,00</b>		3	O	2,6	42	42	<b>40,10</b>
	3	O	1,0	32	42	<b>21,80</b>		4 <sup>v</sup>	O	3,7	42	53	<b>50,60</b>
	4 <sup>v</sup>	O	1,5	32	60	<b>26,50</b>		5 <sup>v</sup>	O	5,0	48	65	<b>59,40</b>
	5 <sup>v</sup>	O	1,8	32	70	<b>33,00</b>		1	x	1,6	38	36	<b>23,40</b>
75▲	1	O	0,5	24	34	<b>9,70</b>	160	2	x	2,6	38	49	<b>33,00</b>
	2	O	1,0	24	49	<b>16,90</b>		3	O	3,0	42	42	<b>41,00</b>
	3	O	1,1	24	42	<b>22,50</b>		4 <sup>v</sup>	O	4,0	42	53	<b>53,00</b>
	4 <sup>v</sup>	O	1,8	24	60	<b>29,70</b>		5 <sup>v</sup>	O	5,2	48	65	<b>62,50</b>
	5 <sup>v</sup>	O	1,9	28	82	<b>34,50</b>		1	x	1,8	38	36	<b>25,70</b>
80▲	1	O	0,6	28	34	<b>10,40</b>	170	2	x	2,4	38	49	<b>36,10</b>
	2	O	1,0	32	49	<b>16,90</b>		3	x	2,8	42	42	<b>45,80</b>
	3	O	1,2	38	42	<b>24,20</b>		4 <sup>v</sup>	O	3,6	48	60	<b>55,40</b>
	4 <sup>v</sup>	O	1,9	38	60	<b>29,70</b>		5 <sup>v</sup>	O	5,5	48	70	<b>64,20</b>
	5 <sup>v</sup>	O	2,0	38	55	<b>37,70</b>		1	x	2,0	35	36	<b>26,40</b>
85	1	O	0,6	24	34	<b>11,30</b>	180	2	x	2,9	35	49	<b>38,50</b>
	2	O	1,2	28	49	<b>18,50</b>		3	x	3,2	35	42	<b>48,20</b>
	3	O	1,4	28	42	<b>24,00</b>		4 <sup>v</sup>	x	4,2	35	60	<b>57,90</b>
	4 <sup>v</sup>	O	2,0	28	53	<b>31,30</b>		5 <sup>v</sup>	x	5,8	38	70	<b>73,00</b>
	5 <sup>v</sup>	O	2,2	32	55	<b>39,40</b>		1	x	2,0	38	36	<b>28,90</b>
90	1	O	0,9	28	34	<b>12,10</b>	190	2	x	3,2	42	49	<b>40,10</b>
	2	O	1,5	32	49	<b>18,50</b>		3	x	3,6	42	42	<b>50,60</b>
	3	O	1,6	38	42	<b>26,40</b>		4 <sup>v</sup>	x	4,7	48	60	<b>62,50</b>
	4 <sup>v</sup>	O	2,2	42	53	<b>33,70</b>		5 <sup>v</sup>	x	6,1	48	70	<b>76,20</b>
	5 <sup>v</sup>	O	2,5	42	67	<b>41,00</b>		1	x	2,0	38	36	<b>31,30</b>
95	1	O	0,8	28	34	<b>12,80</b>	200	2	x	3,2	42	49	<b>41,80</b>
	2	O	1,6	28	49	<b>20,90</b>		3	x	4,0	42	42	<b>54,60</b>
	3	O	1,9	28	42	<b>27,30</b>		4 <sup>v</sup>	x	5,2	48	60	<b>66,70</b>
	4 <sup>v</sup>	O	2,5	32	53	<b>36,10</b>		5 <sup>v</sup>	x	6,3	48	70	<b>80,40</b>
	5 <sup>v</sup>	O	2,8	35	67	<b>43,30</b>		1	x	2,4	38	36	<b>33,00</b>
100	1	O	0,8	28	34	<b>13,70</b>	212	2	x	2,9	42	49	<b>44,30</b>
	2	O	1,4	32	49	<b>20,90</b>		3	x	4,2	48	42	<b>56,20</b>
	3	O	2,0	38	42	<b>28,10</b>		4 <sup>v</sup>	x	5,0	55	60	<b>69,10</b>
	4 <sup>v</sup>	O	2,7	42	53	<b>36,10</b>		5 <sup>v</sup>	x	6,5	55	70	<b>83,40</b>
	5 <sup>v</sup>	O	3,1	42	60	<b>43,30</b>		1	x	2,7	40	36	<b>35,40</b>
106	1	O	0,9	28	34	<b>13,70</b>	225	2	x	3,4	42	49	<b>47,30</b>
	2	O	1,7	28	49	<b>22,50</b>		3	x	4,4	42	42	<b>64,20</b>
	3	O	2,2	32	42	<b>30,60</b>		4 <sup>v</sup>	x	5,7	42	60	<b>73,00</b>
	4 <sup>v</sup>	O	3,2	32	53	<b>38,50</b>		5 <sup>v</sup>	x	6,9	42	70	<b>91,50</b>
	5 <sup>v</sup>	O	3,9	35	60	<b>47,30</b>		1	x	2,8	40	36	<b>39,40</b>
112	1	O	1,1	28	34	<b>15,20</b>	236	2	x	3,9	42	49	<b>50,60</b>
	2	O	1,8	38	49	<b>24,00</b>		3	x	4,6	42	42	<b>65,80</b>
	3	O	2,4	38	42	<b>31,30</b>		4 <sup>v</sup>	x	6,5	42	60	<b>77,90</b>
	4 <sup>v</sup>	O	3,4	42	53	<b>40,10</b>		5 <sup>v</sup>	x	7,3	42	70	<b>95,50</b>
	5 <sup>v</sup>	O	4,0	42	60	<b>48,20</b>		1	x	3,3	38	36	<b>42,60</b>
118	1	O	1,1	32	34	<b>16,90</b>		2	x	4,1	42	49	<b>55,40</b>
	2	O	1,8	38	49	<b>25,70</b>		3	x	4,9	48	47	<b>72,20</b>
	3	O	2,4	42	42	<b>33,70</b>		4 <sup>v</sup>	x	6,2	55	60	<b>85,10</b>
	4 <sup>v</sup>	O	3,4	42	53	<b>42,60</b>		5 <sup>v</sup>	x	7,5	55	70	<b>103,00</b>
	5 <sup>v</sup>	O	4,1	48	65	<b>53,00</b>							

▲ nur für Profil 13 only for section 13

∇ d<sub>d</sub> + 4 mm

Anzahl der Rillen No. of grooves z	1	2	3	4	5
Kranzbreite Face width b <sub>2</sub> (mm)	20	35	50	67	82

- Vollscheibe Solid pulley
  - Bodenscheibe Plate pulley (mit oder ohne Spiegel with or without holes)
  - x Armscheibe Spoked pulley
- Nabenlage: einseitig bündig Hub position: one side flush  
 Material: EN-GJL 200 – DIN EN 1561

**Profil Section SPA/13**

Richt- durchmesser Datum d <sub>g</sub> (mm)	Anzahl der Rillen No. of grooves	Aus- führung Type	Gewicht Weight (≈ kg)	Fertig- bohrung Finished bore d <sub>max</sub> (mm)	Naben- länge Hub length l (mm)	€ Stück zentriert each centered	Richt- durchmesser Datum d <sub>g</sub> (mm)	Anzahl der Rillen No. of grooves	Aus- führung Type	Gewicht Weight (≈ kg)	Fertig- bohrung Finished bore d <sub>max</sub> (mm)	Naben- länge Hub length l (mm)	€ Stück zentriert each centered	
250	1	x	3,4	42	36	<b>44,30</b>	400	1▽	x	6,9	50	50	<b>102,00</b>	
	2	x	4,3	48	49	<b>58,60</b>		2▽	x	8,8	55	53	<b>129,00</b>	
	3	x	5,3	48	47	<b>77,10</b>		3▽	x	10,5	60	47	<b>161,00</b>	
	4▽	x	7,0	55	60	<b>90,70</b>		4▽	x	12,4	60	67	<b>182,00</b>	
	5▽	x	7,9	60	70	<b>109,00</b>		5▽	x	15,9	60	82	<b>210,00</b>	
280	1	x	3,9	42	44	<b>56,20</b>	450	1▽	x	7,5	55	50	<b>125,00</b>	
	2	x	5,4	48	53	<b>71,40</b>		2▽	x	9,4	55	53	<b>150,00</b>	
	3	x	6,5	48	47	<b>90,70</b>		3▽	x	12,2	60	47	<b>178,00</b>	
	4▽	x	8,5	55	60	<b>112,00</b>		4▽	x	14,2	65	67	<b>208,00</b>	
	5▽	x	9,9	60	70	<b>133,00</b>		5▽	x	18,3	65	82	<b>247,00</b>	
300	1	x	4,3	48	44	<b>60,90</b>	500	1▽	x	10,5	55	50	<b>148,00</b>	
	2	x	5,9	48	53	<b>79,50</b>		2▽	x	10,7	55	55	<b>172,00</b>	
	3	x	7,5	55	47	<b>102,00</b>		3▽	x	13,5	60	60	<b>198,00</b>	
	4▽	x	9,8	55	60	<b>122,00</b>		4▽	x	16,3	65	67	<b>245,00</b>	
	5▽	x	11,3	60	70	<b>138,00</b>		5▽	x	22,8	65	82	<b>266,00</b>	
315	1	x	4,8	48	44	<b>68,30</b>	560	1▽	x	14,0	55	60	<b>173,00</b>	
	2	x	6,6	48	53	<b>89,20</b>		2▽	x	13,1	55	60	<b>205,00</b>	
	3	x	8,8	55	47	<b>111,00</b>		3▽	x	15,6	60	74	<b>240,00</b>	
	4▽	x	11,1	55	60	<b>135,00</b>		4▽	x	19,4	65	67	<b>291,00</b>	
	5▽	x	12,5	60	70	<b>143,00</b>		5▽	x	24,5	65	82	<b>300,00</b>	
355	1	x	5,5	48	44	<b>77,90</b>								
	2	x	7,7	55	53	<b>104,00</b>								
	3	x	9,6	55	47	<b>133,00</b>								
	4▽	x	11,8	55	60	<b>156,00</b>								
	5▽	x	13,8	60	70	<b>184,00</b>								
▽ d <sub>d</sub> + 4 mm														

Anzahl der Rillen No. of grooves z	1	2	3	4	5
Kranzbreite Face width b <sub>2</sub> (mm)	20	35	50	67	82

- Vollscheibe *Solid pulley*
  - Bodenscheibe *Plate pulley*  
(mit oder ohne Spiegel *with or without holes*)
  - × Armscheibe *Spoked pulley*
- Nabenlage: einseitig bündig *Hub position: one side flush*  
 Material: EN-GJL 200 – DIN EN 1561

**Profil Section SPB/17**

Richt- durchmesser Datum d <sub>a</sub> (mm)	Anzahl der Rillen No. of grooves	Aus- führung Type	Gewicht Weight (≈ kg)	Fertig- bohrung Finished bore d <sub>max</sub> (mm)	Naben- länge Hub length l (mm)	€ Stück zentriert each centered	Richt- durchmesser Datum d <sub>a</sub> (mm)	Anzahl der Rillen No. of grooves	Aus- führung Type	Gewicht Weight (≈ kg)	Fertig- bohrung Finished bore d <sub>max</sub> (mm)	Naben- länge Hub length l (mm)	€ Stück zentriert each centered
56▲	1	O	0,6	20	41	11,30	132▲	1	O	1,9	30	41	22,50
	2	O	1,0	20	60	17,60		2	O	2,6	30	60	35,40
	3	O	1,1	22	62	25,70		3	O	3,5	42	55	48,20
63▲	1	O	0,8	20	41	11,30		4v	O	6,3	42	70	60,30
	2	O	1,2	20	60	17,60		5v	O	9,4	42	75	75,50
	3	O	1,2	22	62	26,40		6v	O	8,5	42	85	95,50
71▲	1	O	0,8	22	41	11,30	140	1	O	2,1	32	41	24,00
	2	O	1,3	22	60	17,60		2	O	2,9	38	60	36,90
	3	O	1,6	22	55	28,10		3	O	3,9	42	55	50,60
75▲	1	O	0,8	25	41	12,10		4v	O	6,9	42	70	67,40
	2	O	1,4	25	60	19,30		5v	O	7,6	48	75	82,70
	3	O	1,9	25	62	28,10		6v	O	11,4	48	85	99,60
80▲	1	O	1,0	28	41	12,80	150	1	O	2,4	32	43	28,10
	2	O	1,7	28	60	20,90		2	O	3,2	38	48	43,30
	3	O	2,1	28	55	29,70		3	O	4,3	42	60	55,40
	4v	O	2,4	28	70	39,40		4v	O	6,8	42	70	71,40
	5v	O	2,7	28	80	47,30		5v	O	8,4	48	75	86,70
85▲	1	O	1,1	30	41	12,80		6v	O	12,1	48	85	106,00
	2	O	1,7	30	60	21,80	160	1	x	2,5	38	43	30,60
	3	O	2,2	30	55	32,20		2	x	3,3	42	48	45,80
	4v	O	2,7	30	70	41,00		3	x	4,6	48	60	57,90
	5v	O	3,0	30	75	49,80		4v	O	7,0	48	70	73,90
90▲	1	O	1,2	32	41	13,70		5v	O	9,4	48	75	91,50
	2	O	1,8	38	60	23,40		6v	O	12,9	55	85	113,00
	3	O	2,3	38	55	33,70	170	1	x	2,9	42	43	35,40
	4v	O	3,1	38	70	43,30		2	x	3,4	42	48	48,20
	5v	O	3,3	38	75	51,40		3	x	4,9	42	60	63,40
95▲	1	O	1,3	35	41	14,40		4v	O	7,2	48	70	79,50
	2	O	2,0	38	60	24,20		5v	O	8,9	48	75	97,10
	3	O	2,5	38	67	36,10		6v	O	13,1	48	85	120,00
	4v	O	2,9	38	70	44,90	180	1	x	3,1	38	43	36,10
	5v	O	3,6	38	75	55,40		2	x	3,9	42	48	50,60
100▲	1	O	1,3	32	41	16,90		3	x	5,3	48	60	69,10
	2	O	2,1	38	60	26,40		4v	x	7,4	48	70	85,10
	3	O	2,9	38	55	37,70		5v	O	9,1	55	75	104,00
	4v	O	3,8	38	70	48,20		6v	O	10,8	60	85	125,00
	5v	O	4,5	38	75	58,60	190	1	x	3,2	42	43	40,10
	6v	O	5,2	38	124	77,10		2	x	4,2	42	48	56,20
106▲	1	O	1,5	28	41	17,60		3	x	5,5	42	60	73,00
	2	O	2,0	28	60	28,10		4v	x	7,7	48	70	91,50
	3	O	3,0	30	55	39,40		5v	O	9,2	50	75	110,00
	4v	O	4,3	30	70	50,60		6v	O	12,0	55	85	134,00
	5v	O	5,1	32	75	60,90	200	1	x	3,4	38	43	42,60
	6v	O	6,0	32	124	80,40		2	x	4,5	42	48	59,40
112▲	1	O	1,5	32	41	17,60		3	x	5,9	48	60	77,90
	2	O	2,4	38	60	28,90		4v	x	8,0	50	60	97,10
	3	O	3,1	38	55	41,00		5v	O	9,5	55	80	121,00
	4v	O	4,8	42	67	53,00		6v	O	12,2	60	90	148,00
	5v	O	5,6	42	75	65,80	212	1	x	3,8	42	43	47,30
	6v	O	6,2	42	85	92,30		2	x	4,7	42	48	65,00
118▲	1	O	1,6	32	41	19,30		3	x	6,2	48	60	83,40
	2	O	2,4	38	60	31,30		4v	x	7,7	50	70	104,00
	3	O	3,2	42	55	43,30		5v	x	10,3	50	80	125,00
	4v	O	5,2	42	70	55,40		6v	O	13,5	55	90	156,00
	5v	O	7,2	42	75	71,40	225	1	x	4,0	42	43	50,60
	6v	O	6,6	42	85	89,80		2	x	5,4	42	48	69,10
125▲	1	O	1,7	32	41	20,90		3	x	6,9	48	60	89,20
	2	O	2,6	38	60	33,00		4v	x	8,6	55	70	113,00
	3	O	3,3	42	55	44,30		5v	O	11,7	50	90	134,00
	4v	O	4,7	42	70	57,00		6v	O	14,8	55	90	172,00
	5v	O	8,6	42	75	73,00							
	6v	O	8,0	48	85	93,10							

▲ nur für Profil 17 only for section 17

▽ d<sub>d</sub> + 5,5 mm

Anzahl der Rillen No. of grooves z	1	2	3	4	5	6
Kranzbreite Face width b <sub>2</sub> (mm)	25	44	63	86	105	124

- Vollscheibe Solid pulley
  - Bodenscheibe Plate pulley (mit oder ohne Spiegel with or without holes)
  - × Armscheibe Spoked pulley
- Nabenlage: einseitig bündig Hub position: one side flush  
 Material: EN-GJL 200 – DIN EN 1561



**Profil Section SPB/17**

Richt- durchmesser Datum d <sub>d</sub> (mm)	Anzahl der Rillen No. of grooves	Aus- führung Type	Gewicht Weight (≈ kg)	Fertig- bohrung Finished bore d <sub>max</sub> (mm)	Naben- länge Hub length l (mm)	€ Stück zentriert each centered	Richt- durchmesser Datum d <sub>d</sub> (mm)	Anzahl der Rillen No. of grooves	Aus- führung Type	Gewicht Weight (≈ kg)	Fertig- bohrung Finished bore d <sub>max</sub> (mm)	Naben- länge Hub length l (mm)	€ Stück zentriert each centered
250	1	x	4,2	42	43	<b>59,40</b>	400	1▽	x	8,5	50	49	<b>125,00</b>
	2	x	6,1	48	55	<b>80,40</b>		2▽	x	10,0	55	55	<b>159,00</b>
	3	x	8,6	55	60	<b>104,00</b>		3▽	x	14,3	60	67	<b>188,00</b>
	4▽	x	9,8	60	70	<b>131,00</b>		4▽	x	18,5	65	80	<b>260,00</b>
	5▽	x	13,2	65	80	<b>152,00</b>		5▽	x	22,5	70	85	<b>271,00</b>
	6▽	x	17,0	65	90	<b>184,00</b>		6▽	x	28,0	75	90	<b>298,00</b>
280	1	x	5,7	48	49	<b>69,90</b>	450	1▽	x	9,9	50	55	<b>135,00</b>
	2	x	7,0	48	55	<b>94,70</b>		2▽	x	10,9	55	55	<b>188,00</b>
	3	x	9,7	55	60	<b>119,00</b>		3▽	x	15,1	60	67	<b>222,00</b>
	4▽	x	11,5	60	70	<b>143,00</b>		4▽	x	20,5	65	80	<b>293,00</b>
	5▽	x	15,5	65	80	<b>172,00</b>		5▽	x	26,0	70	80	<b>350,00</b>
	6▽	x	18,0	65	90	<b>203,00</b>		6▽	x	28,9	75	90	<b>409,00</b>
300	1	x	5,9	48	49	<b>77,90</b>	500	1▽	x	10,7	50	55	<b>159,00</b>
	2	x	7,5	48	55	<b>104,00</b>		2▽	x	13,7	60	59	<b>208,00</b>
	3	x	10,5	55	67	<b>129,00</b>		3▽	x	15,2	65	67	<b>255,00</b>
	4▽	x	12,4	60	80	<b>156,00</b>		4▽	x	21,3	70	80	<b>339,00</b>
	5▽	x	16,5	65	80	<b>186,00</b>		5▽	x	30,0	75	80	<b>423,00</b>
	6▽	x	18,3	70	90	<b>217,00</b>		6▽	x	33,8	80	90	<b>562,00</b>
315	1	x	6,4	48	49	<b>84,30</b>	560	2▽	x	15,0	60	55	<b>274,00</b>
	2	x	8,2	55	55	<b>105,00</b>		3▽	x	24,2	65	67	<b>354,00</b>
	3	x	12,9	55	67	<b>140,00</b>		4▽	x	26,0	70	80	<b>437,00</b>
	4▽	x	13,0	60	80	<b>169,00</b>		5▽	x	34,4	75	80	<b>514,00</b>
	5▽	x	17,6	65	80	<b>195,00</b>		6▽	x	39,0	80	90	<b>593,00</b>
	6▽	x	20,6	75	90	<b>221,00</b>		630	2▽	x	20,2	60	80
355	1	x	7,0	48	49	<b>99,60</b>	3▽		x	27,0	65	80	<b>398,00</b>
	2	x	9,7	55	55	<b>134,00</b>	4▽		x	30,8	75	86	<b>539,00</b>
	3	x	13,4	55	67	<b>161,00</b>	5▽		x	37,2	80	90	<b>598,00</b>
	4▽	x	18,3	60	80	<b>210,00</b>	6▽		x	44,0	90	100	<b>665,00</b>
	5▽	x	18,8	65	75	<b>222,00</b>							
	6▽	x	19,8	75	90	<b>269,00</b>							
▽ d <sub>d</sub> + 5,5 mm													

Anzahl der Rillen No. of grooves z	1	2	3	4	5	6
Kranzbreite Face width b <sub>2</sub> (mm)	25	44	63	86	105	124

- Vollscheibe Solid pulley
  - Bodenscheibe Plate pulley (mit oder ohne Spiegel with or without holes)
  - × Armscheibe Spoked pulley
- Nabenlage: einseitig bündig Hub position: one side flush  
 Material: EN-GJL 200 – DIN EN 1561

**Profil Section SPC/22** (keine Lagerware *non stock items*)

Richt- durchmesser Datum diameter d <sub>g</sub> (mm)	Anzahl der Rillen No. of grooves	Aus- führung Type	Gewicht Weight (≈ kg)	Fertig- bohrung Finished bore d <sub>max</sub> (mm)	Naben- länge Hub length l (mm)	€ Stück zentriert each centered	Richt- durchmesser Datum diameter d <sub>g</sub> (mm)	Anzahl der Rillen No. of grooves	Aus- führung Type	Gewicht Weight (≈ kg)	Fertig- bohrung Finished bore d <sub>max</sub> (mm)	Naben- länge Hub length l (mm)	€ Stück zentriert each centered	
180	1	O	4,2	40	54	<b>75,50</b>	335	2	x	14,0	55	74	<b>176,00</b>	
	2	O	7,2	50	64	<b>86,70</b>		3	x	18,3	55	90	<b>225,00</b>	
	3	O	10,4	55	90	<b>109,00</b>		4	x	22,4	60	95	<b>287,00</b>	
	4	O	10,5	55	95	<b>172,00</b>		5	x	28,3	65	100	<b>357,00</b>	
	5	O	18,0	60	100	<b>195,00</b>		6	x	34,4	75	115	<b>419,00</b>	
	6	O	23,6	65	115	<b>222,00</b>		355	2	x	15,2	60	74	<b>170,00</b>
200	1	O	4,8	40	54	<b>85,10</b>	3		x	19,2	70	90	<b>229,00</b>	
	2	O	7,8	50	64	<b>95,50</b>	4		x	25,8	70	95	<b>290,00</b>	
	3	O	8,8	55	90	<b>121,00</b>	5		x	32,0	75	100	<b>344,00</b>	
	4	O	11,2	60	95	<b>200,00</b>	6		x	36,2	75	115	<b>398,00</b>	
	5	O	15,4	65	100	<b>226,00</b>	400		3	x	20,6	70	90	<b>263,00</b>
	6	O	27,0	70	125	<b>252,00</b>		4	x	28,0	70	105	<b>289,00</b>	
225	1	x	5,5	48	54	<b>97,10</b>		5	x	32,0	75	100	<b>441,00</b>	
	2	x	7,8	52	64	<b>128,00</b>		450	2	x	21,1	70	80	<b>222,00</b>
	3	x	10,6	52	90	<b>133,00</b>			3	x	26,3	75	90	<b>315,00</b>
	4	x	13,1	55	95	<b>228,00</b>			4	x	31,1	75	105	<b>350,00</b>
	5	x	16,7	60	100	<b>238,00</b>	5		x	42,2	80	110	<b>475,00</b>	
	6	x	35,0	60	115	<b>270,00</b>	6		x	48,5	80	120	<b>529,00</b>	
250	1	x	7,3	52	54	<b>105,00</b>	500		3	x	28,4	75	90	<b>356,00</b>
	2	x	8,8	52	64	<b>139,00</b>		4	x	34,1	75	105	<b>403,00</b>	
	3	x	11,0	65	90	<b>161,00</b>		5	x	48,2	80	110	<b>535,00</b>	
	4	x	15,3	70	95	<b>247,00</b>		6	x	52,5	80	120	<b>598,00</b>	
	5	x	19,0	75	100	<b>253,00</b>		560	3	x	31,1	75	90	<b>418,00</b>
	6	x	23,7	60	115	<b>279,00</b>			4	x	39,0	75	105	<b>479,00</b>
280	1	x	8,7	52	54	<b>122,00</b>	5		x	54,1	80	110	<b>639,00</b>	
	2	x	10,9	55	64	<b>151,00</b>	6		x	61,5	85	120	<b>822,00</b>	
	3	x	15,6	70	90	<b>188,00</b>	630		3	x	38,5	80	90	<b>494,00</b>
	4	x	17,5	75	95	<b>270,00</b>			4	x	48,1	80	105	<b>650,00</b>
	5	x	20,5	75	100	<b>305,00</b>		5	x	62,2	85	110	<b>744,00</b>	
	315	1	x	9,1	52	54		<b>131,00</b>	6	x	73,2	85	120	<b>1.043,00</b>
2		x	13,0	55	74	<b>161,00</b>								
3		x	17,1	70	90	<b>220,00</b>								
4		x	20,0	75	95	<b>283,00</b>								
5		x	24,7	80	100	<b>323,00</b>								
6		x	31,2	85	115	<b>381,00</b>								

Anzahl der Rillen No. of grooves z	1	2	3	4	5	6
Kranzbreite Face width b <sub>2</sub> (mm)	38	64	90	116	142	168

- Vollscheibe *Solid pulley*
  - O Bodenscheibe *Plate pulley*  
(mit oder ohne Spiegel *with or without holes*)
  - × Armscheibe *Spoked pulley*
- Nabenlage: einseitig bündig *Hub position: one side flush*  
 Material: EN-GJL 200 – DIN EN 1561



Regelscheiben für zylindrische Bohrung <i>Variable speed pulleys for plain boring</i> Material: GG										
Bezeichnung Part Number	D <sub>A</sub> (mm)	D (mm)	Fertigbohrung Finished bore d <sub>max</sub> (mm)	B (mm)	Profil Section	d <sub>d min</sub> (mm)	d <sub>d max</sub> (mm)	Regel- faktor Variance factor	Gewicht Weight (= kg)	€ Stück zentriert each centered
R 083-1	83	40	26	48	SPZ Z/10	63 57	79 77	1,25 1,35	0,90	<b>60,70</b>
R 093-1	93	45	28	48	SPZ SPA Z/10 A/13	67 66 61 60	89 87 87 85	1,33 1,32 1,43 1,42	1,03	<b>67,30</b>
R 108-1	108	50	28	48	SPZ SPA Z/10 A/13	79 81 73 75	94 102 93 100	1,19 1,26 1,27 1,33	1,65	<b>71,30</b>
R 121-1	121	55	28	48	SPZ SPA Z/10 A/13	92 94 86 88	107 115 106 113	1,16 1,22 1,23 1,28	1,75	<b>79,20</b>
R 138-1	138	55	38	48	SPZ SPA SPB Z/10 A/13 B/17	109 111 116 103 105 109	124 132 131 123 130 128	1,14 1,19 1,13 1,19 1,24 1,17	2,60	<b>93,40</b>
R 160-1	160	80	52	48	SPZ SPA SPB Z/10 A/13 B/17	119 121 126 113 115 119	134 143 153 133 141 150	1,13 1,18 1,21 1,18 1,23 1,26	4,50	<b>114,00</b>
R 180-1	180	80	52	48	SPA SPB A/13 B/17	141 146 135 139	163 173 161 170	1,16 1,18 1,19 1,22	5,40	<b>144,00</b>



**Regelscheiben für zylindrische Bohrung *Variable speed pulleys for plain boring*** Material: GG

Bezeichnung <i>Part Number</i>	D <sub>A</sub> (mm)	D (mm)	Fertigbohrung <i>Finished bore</i> d <sub>max</sub> (mm)	B (mm)	Profil <i>Section</i>	d <sub>d min</sub> (mm)	d <sub>d max</sub> (mm)	Regel- faktor <i>Variance</i> factor	Gewicht <i>Weight</i> (= kg)	€ Stück zentriert <i>each</i> centered
R 083-2	83	40	26	76	SPZ Z/10	63 57	79 77	1,25 1,35	1,50	<b>104,00</b>
R 093-2	93	45	28	76	SPZ SPA Z/10 A/13	67 66 61 60	89 87 87 85	1,33 1,32 1,43 1,42	1,75	<b>114,00</b>
R 108-2	108	50	28	76	SPZ SPA Z/10 A/13	79 81 73 75	94 102 93 100	1,19 1,26 1,27 1,33	2,15	<b>121,00</b>
R 121-2	121	55	28	76	SPZ SPA Z/10 A/13	92 94 86 88	107 115 106 113	1,16 1,22 1,23 1,28	2,70	<b>144,00</b>
R 138-2	138	55	38	76	SPZ SPA SPB Z/10 A/13 B/17	109 111 116 103 105 109	124 132 131 123 130 128	1,14 1,19 1,13 1,19 1,24 1,17	4,50	<b>157,00</b>
R 160-2	160	80	52	90	SPZ SPA SPB Z/10 A/13 B/17	119 121 126 113 115 119	134 143 153 133 141 150	1,13 1,18 1,21 1,18 1,23 1,26	7,50	<b>205,00</b>
R 180-2	180	80	52	90	SPA SPB A/13 B/17	141 146 135 139	163 173 161 170	1,16 1,18 1,19 1,22	9,20	<b>253,00</b>

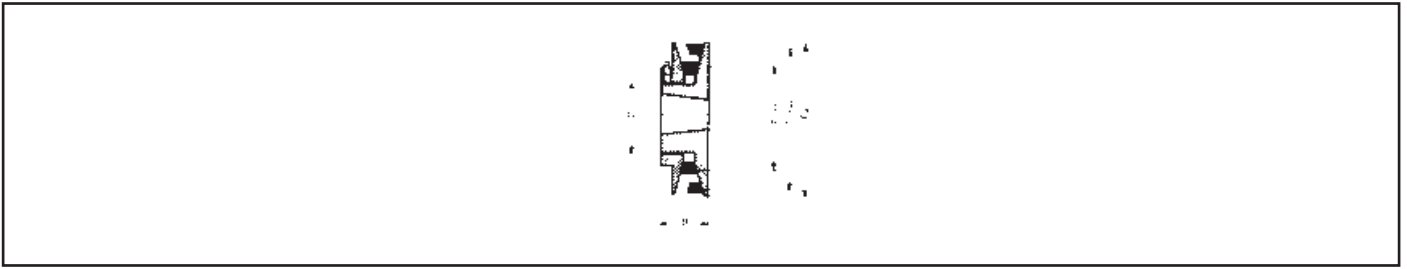

Regelscheiben für Taper-Buchsen <i>Variable speed pulleys for taper bushes</i>											Material: GG
Bezeichnung Part Number	D <sub>A</sub> (mm)	D (mm)	Fertigbohrung Finished bore d <sub>max</sub> (mm)	B (mm)	Profil Section	d <sub>d min</sub> (mm)	d <sub>d max</sub> (mm)	Regel- faktor Variance factor	Gewicht ohne Buchse Weight without bush (= kg)	Taper- Buchse Taper bush	€ Stück ohne Buchse each without bush
TB-R 092-1	92	46	25	31	SPZ Z/10	60 55	89 88	1,48 1,60	0,85	1008	<b>64,80</b>
TB-R 108-1	108	50	28	35	SPZ SPA Z/10 A/13 B/17	75 76 68 70 87	93 102 92 100 97	1,24 1,34 1,35 1,43 1,11	1,20	1108	<b>71,20</b>
TB-R 120-1	120	55	28	35	SPZ SPA Z/10 A/13 B/17	87 88 80 82 98	105 114 104 112 108	1,20 1,29 1,30 1,36 1,10	1,50	1108	<b>80,60</b>
TB-R 138-1	138	65	32	38	SPZ SPA Z/10 A/13 B/17	105 106 98 100 116	123 132 122 130 126	1,17 1,24 1,24 1,30 1,09	2,20	1215	<b>101,00</b>
TB-R 159-1	159	75	42	39	SPZ SPA Z/10 A/13 B/17	126 128 122 128 125	144 154 152 152 148	1,14 1,20 1,24 1,18 1,18	3,50	1615	<b>125,00</b>
TB-R 180-1	180	75	42	45	SPZ SPA SPB Z/10 A/13 B/17	133 134 137 128 128 132	151 160 173 151 158 170	1,14 1,19 1,26 1,17 1,23 1,29	4,20	1615	<b>157,00</b>

Taper-Buchse Taper bush	1008	1108	1215	1615
Bohrung d <sub>2</sub> (mm) von ... bis ... Bore d <sub>2</sub> (mm) from ... to ...	10-25	10-28	11-32	14-42
€/Stück each	<b>6,90</b>	<b>7,90</b>	<b>13,00</b>	<b>13,00</b>

GG = Grauguss Cast iron  
Fertigungstechnische Änderungen vorbehalten. We reserve the right to technical changes.  
Bohrungsdurchmesser d<sub>2</sub> siehe Seite 3.  
Bore diameters d<sub>2</sub> see page 3.

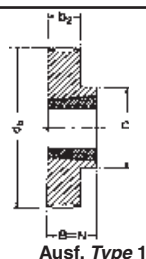

Ausf. Type 1



Ausf. Type 4

Bezeichnung Part Number	Anzahl der Rillen No. of ribs	Aus- führung Type	Material	d <sub>b</sub> (mm)	b <sub>2</sub> (mm)	B (mm)	N (mm)	D (mm)	Taper- Buchse Taper bush	€ Stück ohne Buchse each without bush
TB 4 PJ 47,5	4	1	GG	47,5	13	23	23	47,5	1008	52,30
TB 4 PJ 52,5	4	1	GG	52,5	13	23	23	47,5	1008	52,80
TB 4 PJ 57,5	4	1	GG	57,5	13	23	23	54,0	1108	53,30
TB 4 PJ 62,5	4	1	GG	62,5	13	23	23	54,0	1108	53,70
TB 4 PJ 67,5	4	1	GG	67,5	13	23	23	54,0	1108	54,10
TB 4 PJ 72,5	4	1	GG	72,5	13	23	23	54,0	1108	54,90
TB 4 PJ 77,5	4	1	GG	77,5	13	26	26	70,0	1210	55,80
TB 4 PJ 82,5	4	1	GG	82,5	13	26	26	78,0	1210	56,50
TB 4 PJ 87,5	4	1	GG	87,5	13	26	26	78,0	1210	57,20
TB 4 PJ 92,5	4	1	GG	92,5	13	26	26	78,0	1210	58,50
TB 4 PJ 97,5	4	1	GG	97,5	13	26	26	78,0	1210	59,00
TB 4 PJ 102,5	4	1	GG	102,5	13	26	26	85,0	1610	64,80
TB 4 PJ 107,5	4	1	GG	107,5	13	26	26	85,0	1610	74,60
TB 4 PJ 112,5	4	1	GG	112,5	13	26	26	85,0	1610	76,00
TB 4 PJ 117,5	4	1	GG	117,5	13	26	26	85,0	1610	76,50
TB 4 PJ 122,5	4	1	GG	122,5	13	26	26	85,0	1610	77,80
TB 4 PJ 127,5	4	1	GG	127,5	13	26	26	85,0	1610	78,30
TB 4 PJ 137,5	4	1	GG	137,5	13	26	26	85,0	1610	80,90
TB 4 PJ 152,5	4	1	GG	152,5	13	26	26	85,0	1610	84,70
TB 4 PJ 162,5	4	1	GG	162,5	13	26	26	85,0	1610	87,10
TB 4 PJ 172,5	4	1	GG	172,5	13	26	26	85,0	1610	90,20
TB 4 PJ 182,5	4	1	GG	182,5	13	26	26	85,0	1610	93,30
TB 4 PJ 192,5	4	1	GG	192,5	13	26	26	85,0	1610	95,90
TB 4 PJ 202,5	4	1	GG	202,5	13	33	33	100,0	2012	108,00
TB 4 PJ 222,5	4	1	GG	222,5	13	33	33	100,0	2012	114,00
TB 8 PJ 47,5	8	4	GG	47,5	23	23	23	—	1008	53,40
TB 8 PJ 52,5	8	4	GG	52,5	23	23	23	—	1008	53,80
TB 8 PJ 57,5	8	4	GG	57,5	23	23	23	—	1108	54,20
TB 8 PJ 62,5	8	4	GG	62,5	23	23	23	—	1108	54,90
TB 8 PJ 67,5	8	4	GG	67,5	23	23	23	—	1108	55,20
TB 8 PJ 72,5	8	4	GG	72,5	23	23	23	—	1108	56,10
TB 8 PJ 77,5	8	1	GG	77,5	23	26	26	70,0	1210	57,00
TB 8 PJ 82,5	8	1	GG	82,5	23	26	26	78,0	1210	57,80
TB 8 PJ 87,5	8	1	GG	87,5	23	26	26	78,0	1210	58,40
TB 8 PJ 92,5	8	1	GG	92,5	23	26	26	78,0	1210	59,80
TB 8 PJ 97,5	8	1	GG	97,5	23	26	26	78,0	1210	60,40
TB 8 PJ 102,5	8	1	GG	102,5	23	26	26	85,0	1610	65,90
TB 8 PJ 107,5	8	1	GG	107,5	23	26	26	85,0	1610	76,50
TB 8 PJ 112,5	8	1	GG	112,5	23	26	26	85,0	1610	77,20
TB 8 PJ 117,5	8	1	GG	117,5	23	26	26	85,0	1610	78,30
TB 8 PJ 122,5	8	1	GG	122,5	23	26	26	85,0	1610	79,00
TB 8 PJ 127,5	8	1	GG	127,5	23	26	26	85,0	1610	80,40
TB 8 PJ 137,5	8	1	GG	137,5	23	26	26	85,0	1610	82,70
TB 8 PJ 152,5	8	1	GG	152,5	23	26	26	85,0	1610	86,50
TB 8 PJ 162,5	8	1	GG	162,5	23	26	26	85,0	1610	90,90
TB 8 PJ 172,5	8	1	GG	172,5	23	26	26	85,0	1610	94,60
TB 8 PJ 182,5	8	1	GG	182,5	23	26	26	85,0	1610	97,70
TB 8 PJ 192,5	8	1	GG	192,5	23	26	26	85,0	1610	101,00
TB 8 PJ 202,5	8	1	GG	202,5	23	33	33	100,0	2012	113,00
TB 8 PJ 222,5	8	1	GG	222,5	23	33	33	100,0	2012	120,00

Taper-Buchse Taper bush	1008	1108	1210	1610	2012
Bohrung d <sub>2</sub> (mm) von ... bis ... Bore d <sub>2</sub> (mm) from ... to ...	10-25	10-28	11-32	14-42	14-50
€/Stück each	6,90	7,90	10,40	12,40	15,20

GG = Grauguss Cast iron  
 Weitere Abmessungen auf Anfrage.  
 Further sizes on request.  
 Fertigungstechnische Änderungen vorbehalten.  
 We reserve the right to make technical changes.  
 Bohrungsdurchmesser d<sub>2</sub> siehe Seite 3.  
 Bore diameters d<sub>2</sub> see page 3.

**optibelt RBS** Keilrippenscheiben für Taper-Buchsen, Profil PJ  
*Ribbed belt pulleys for taper bushes, section PJ*

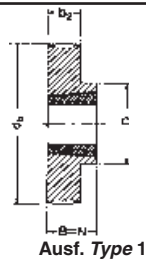

Bezeichnung Part Number	Anzahl der Rillen No. of ribs	Aus- führung Type	Material	d <sub>b</sub> (mm)	b <sub>2</sub> (mm)	B (mm)	N (mm)	D (mm)	Taper- Buchse Taper bush	€ Stück ohne Buchse each without bush
TB 12 PJ 62,5	12	2	GG	62,5	32	32	23	50,0	1108	55,90
TB 12 PJ 67,5	12	2	GG	67,5	32	32	23	50,0	1108	56,40
TB 12 PJ 72,5	12	2	GG	72,5	32	32	23	50,0	1108	57,20
TB 12 PJ 77,5	12	2	GG	77,5	32	32	26	62,0	1210	58,20
TB 12 PJ 82,5	12	2	GG	82,5	32	32	26	62,0	1210	58,90
TB 12 PJ 87,5	12	2	GG	87,5	32	32	26	70,0	1610	64,80
TB 12 PJ 92,5	12	2	GG	92,5	32	32	26	70,0	1610	65,90
TB 12 PJ 97,5	12	2	GG	97,5	32	32	26	70,0	1610	66,60
TB 12 PJ 102,5	12	2	GG	102,5	32	32	26	70,0	1610	67,80
TB 12 PJ 107,5	12	2	GG	107,5	32	32	26	70,0	1610	77,80
TB 12 PJ 112,5	12	2	GG	112,5	32	32	26	70,0	1610	79,00
TB 12 PJ 117,5	12	2	GG	117,5	32	32	26	70,0	1610	80,40
TB 12 PJ 122,5	12	2	GG	122,5	32	32	26	70,0	1610	80,90
TB 12 PJ 127,5	12	1	GG	127,5	32	32	33	100,0	2012	90,20
TB 12 PJ 137,5	12	1	GG	137,5	32	32	33	100,0	2012	92,80
TB 12 PJ 152,5	12	1	GG	152,5	32	32	33	100,0	2012	96,50
TB 12 PJ 162,5	12	1	GG	162,5	32	32	33	100,0	2012	101,00
TB 12 PJ 172,5	12	1	GG	172,5	32	32	33	100,0	2012	105,00
TB 12 PJ 182,5	12	1	GG	182,5	32	46	46	110,0	2517	116,00
TB 12 PJ 192,5	12	1	GG	192,5	32	46	46	110,0	2517	120,00
TB 12 PJ 202,5	12	1	GG	202,5	32	46	46	110,0	2517	124,00
TB 12 PJ 222,5	12	1	GG	222,5	32	46	46	110,0	2517	132,00
TB 16 PJ 62,5	16	2	GG	62,5	41	41	23	50,0	1108	57,40
TB 16 PJ 67,5	16	2	GG	67,5	41	41	23	50,0	1108	58,00
TB 16 PJ 72,5	16	2	GG	72,5	41	41	26	62,0	1210	58,80
TB 16 PJ 77,5	16	2	GG	77,5	41	41	26	62,0	1210	59,60
TB 16 PJ 82,5	16	2	GG	82,5	41	41	26	62,0	1210	60,30
TB 16 PJ 87,5	16	2	GG	87,5	41	41	26	70,0	1610	65,90
TB 16 PJ 92,5	16	2	GG	92,5	41	41	26	70,0	1610	67,30
TB 16 PJ 97,5	16	2	GG	97,5	41	41	26	70,0	1610	67,80
TB 16 PJ 102,5	16	2	GG	102,5	41	41	26	70,0	1610	69,10
TB 16 PJ 107,5	16	2	GG	107,5	41	41	26	70,0	1610	87,80
TB 16 PJ 112,5	16	2	GG	112,5	41	41	33	85,0	2012	89,00
TB 16 PJ 117,5	16	2	GG	117,5	41	41	33	85,0	2012	89,60
TB 16 PJ 122,5	16	2	GG	122,5	41	41	33	85,0	2012	90,90
TB 16 PJ 127,5	16	2	GG	127,5	41	41	33	85,0	2012	92,10
TB 16 PJ 137,5	16	2	GG	137,5	41	41	33	85,0	2012	94,60
TB 16 PJ 152,5	16	2	GG	152,5	41	41	33	85,0	2012	98,90
TB 16 PJ 162,5	16	2	GG	162,5	41	41	33	85,0	2012	106,00
TB 16 PJ 172,5	16	2	GG	172,5	41	41	33	85,0	2012	110,00
TB 16 PJ 182,5	16	1	GG	182,5	41	46	46	110,0	2517	122,00
TB 16 PJ 192,5	16	1	GG	192,5	41	46	46	110,0	2517	125,00
TB 16 PJ 202,5	16	1	GG	202,5	41	46	46	110,0	2517	129,00
TB 16 PJ 222,5	16	1	GG	222,5	41	46	46	110,0	2517	138,00

Taper-Buchse Taper bush	1108	1210	1610	2012	2517
Bohrung d <sub>2</sub> (mm) von ... bis ... Bore d <sub>2</sub> (mm) from ... to ...	10-28	11-32	14-42	14-50	16-60
€/Stück each	7,90	10,40	12,40	15,20	19,10

GG = Grauguss Cast iron  
 Weitere Abmessungen auf Anfrage.  
 Further sizes on request.  
 Fertigungstechnische Änderungen vorbehalten.  
 We reserve the right to make technical changes.  
 Bohrungsdurchmesser d<sub>2</sub> siehe Seite 3.  
 Bore diameters d<sub>2</sub> see page 3.

**optibelt RBS** Keilrippenscheiben für Taper-Buchsen, Profil PL (keine Lagerware)  
**Ribbed belt pulleys for taper bushes, section PL (non stock items)**

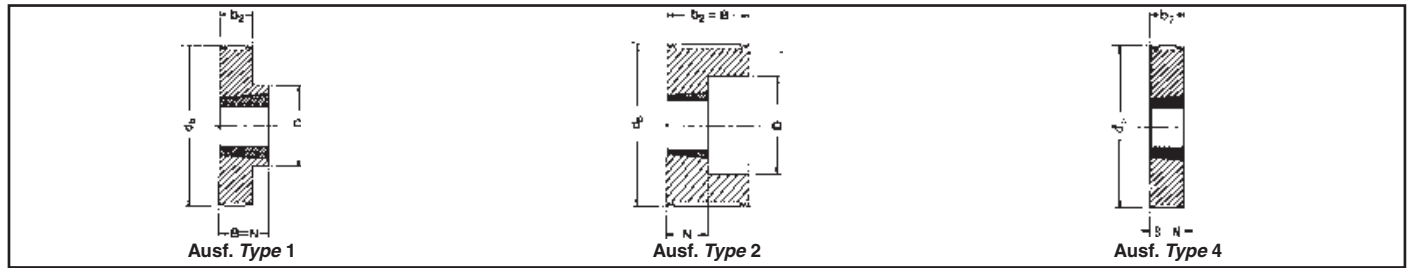

Bezeichnung Part Number	Anzahl der Rillen No. of ribs	Aus- führung Type	Material	d <sub>b</sub> (mm)	b <sub>2</sub> (mm)	B (mm)	N (mm)	D (mm)	Taper- Buchse Taper bush	€ Stück ohne Buchse each without bush
TB 6 PL 78	6	2	GG	78	33	33	26	62,0	1210	66,60
TB 6 PL 83	6	2	GG	83	33	33	26	62,0	1210	72,80
TB 6 PL 88	6	2	GG	88	33	33	26	70,0	1610	74,00
TB 6 PL 93	6	2	GG	93	33	33	26	70,0	1610	75,40
TB 6 PL 98	6	2	GG	98	33	33	26	70,0	1610	76,00
TB 6 PL 103	6	2	GG	103	33	33	26	70,0	1610	89,00
TB 6 PL 108	6	2	GG	108	33	33	26	70,0	1610	90,20
TB 6 PL 113	6	2	GG	113	33	33	26	70,0	1610	90,90
TB 6 PL 118	6	2	GG	118	33	33	26	70,0	1610	92,10
TB 6 PL 123	6	4	GG	123	33	33	33	—	2012	102,00
TB 6 PL 133	6	4	GG	133	33	33	33	—	2012	105,00
TB 6 PL 148	6	4	GG	148	33	33	33	—	2012	110,00
TB 6 PL 158	6	4	GG	158	33	33	33	—	2012	115,00
TB 6 PL 168	6	4	GG	168	33	33	33	—	2012	120,00
TB 6 PL 178	6	1	GG	178	33	46	46	110,0	2517	132,00
TB 6 PL 188	6	1	GG	188	33	46	46	110,0	2517	135,00
TB 6 PL 198	6	1	GG	198	33	46	46	110,0	2517	140,00
TB 6 PL 218	6	1	GG	218	33	46	46	110,0	2517	150,00
TB 6 PL 238	6	1	GG	238	33	46	46	110,0	2517	295,00
TB 6 PL 258	6	1	GG	258	33	46	46	110,0	2517	308,00
TB 6 PL 278	6	1	GG	278	33	46	46	110,0	2517	322,00
TB 6 PL 298	6	1	GG	298	33	46	46	110,0	2517	337,00
TB 6 PL 318	6	1	GG	318	33	46	46	110,0	2517	374,00
TB 6 PL 348	6	1	GG	348	33	46	46	110,0	2517	402,00
TB 6 PL 388	6	1	GG	388	33	46	46	110,0	2517	449,00
TB 8 PL 78	8	2	GG	78	42	42	26	62,0	1210	70,30
TB 8 PL 83	8	2	GG	83	42	42	26	62,0	1210	70,90
TB 8 PL 88	8	2	GG	88	42	42	26	70,0	1610	77,80
TB 8 PL 93	8	2	GG	93	42	42	26	70,0	1610	79,00
TB 8 PL 98	8	2	GG	98	42	42	26	70,0	1610	79,70
TB 8 PL 103	8	2	GG	103	42	42	33	85,0	2012	101,00
TB 8 PL 108	8	2	GG	108	42	42	33	85,0	2012	103,00
TB 8 PL 113	8	2	GG	113	42	42	33	85,0	2012	104,00
TB 8 PL 118	8	2	GG	118	42	42	33	85,0	2012	106,00
TB 8 PL 123	8	2	GG	123	42	42	33	85,0	2012	107,00
TB 8 PL 133	8	2	GG	133	42	42	33	85,0	2012	110,00
TB 8 PL 148	8	2	GG	148	42	42	33	85,0	2012	115,00
TB 8 PL 158	8	2	GG	158	42	42	33	85,0	2012	122,00
TB 8 PL 168	8	2	GG	168	42	42	33	85,0	2012	126,00
TB 8 PL 178	8	1	GG	178	42	46	46	110,0	2517	139,00
TB 8 PL 188	8	1	GG	188	42	46	46	110,0	2517	143,00
TB 8 PL 198	8	1	GG	198	42	46	46	110,0	2517	149,00
TB 8 PL 218	8	1	GG	218	42	46	46	110,0	2517	158,00
TB 8 PL 238	8	1	GG	238	42	46	46	110,0	2517	315,00
TB 8 PL 258	8	1	GG	258	42	46	46	110,0	2517	328,00
TB 8 PL 278	8	1	GG	278	42	46	46	110,0	2517	343,00
TB 8 PL 298	8	1	GG	298	42	46	46	110,0	2517	361,00
TB 8 PL 318	8	1	GG	318	42	46	46	110,0	2517	398,00
TB 8 PL 348	8	1	GG	348	42	46	46	110,0	2517	431,00
TB 8 PL 388	8	1	GG	388	42	46	46	110,0	2517	482,00

Taper-Buchse Taper bush	1210	1610	2012	2517
Bohrung d <sub>2</sub> (mm) von ... bis ... Bore d <sub>2</sub> (mm) from ... to ...	11-32	14-42	14-50	16-60
€/Stück each	10,40	13,00	15,20	19,10

GG = Grauguss Cast iron  
 Weitere Abmessungen auf Anfrage.  
 Further sizes on request.  
 Fertigungstechnische Änderungen vorbehalten.  
 We reserve the right to make technical changes.  
 Bohrungsdurchmesser d<sub>2</sub> siehe Seite 3.  
 Bore diameters d<sub>2</sub> see page 3.



**optibelt RBS** Keilrippenscheiben für Taper-Buchsen, Profil PL (keine Lagerware)  
**Ribbed belt pulleys for taper bushes, section PL (non stock items)**

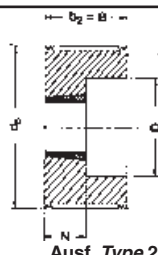

Ausf. Type 2

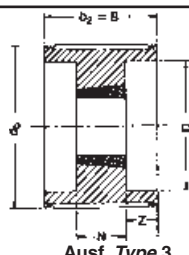

Ausf. Type 3

Bezeichnung Part Number	Anzahl der Rillen No. of ribs	Aus- führung Type	Material	$d_b$ (mm)	$b_2$ (mm)	B (mm)	N (mm)	D (mm)	Taper- Buchse Taper bush	€ Stück ohne Buchse each without bush
TB 10 PL 88	10	3	GG	88	53	53	26	70,0	1610	102,00
TB 10 PL 93	10	3	GG	93	53	53	26	70,0	1610	103,00
TB 10 PL 98	10	3	GG	98	53	53	26	70,0	1610	105,00
TB 10 PL 103	10	2	GG	103	53	53	33	85,0	2012	133,00
TB 10 PL 108	10	2	GG	108	53	53	33	85,0	2012	135,00
TB 10 PL 113	10	2	GG	113	53	53	33	85,0	2012	137,00
TB 10 PL 118	10	2	GG	118	53	53	33	85,0	2012	139,00
TB 10 PL 123	10	2	GG	123	53	53	33	85,0	2012	141,00
TB 10 PL 133	10	2	GG	133	53	53	33	85,0	2012	144,00
TB 10 PL 148	10	2	GG	148	53	53	33	85,0	2012	152,00
TB 10 PL 158	10	2	GG	158	53	53	33	85,0	2012	159,00
TB 10 PL 168	10	2	GG	168	53	53	33	85,0	2012	167,00
TB 10 PL 178	10	2	GG	178	53	53	46	105,0	2517	183,00
TB 10 PL 188	10	2	GG	188	53	53	46	105,0	2517	188,00
TB 10 PL 198	10	2	GG	198	53	53	46	105,0	2517	194,00
TB 10 PL 218	10	2	GG	218	53	53	46	105,0	2517	209,00
TB 10 PL 238	10	2	GG	238	53	53	46	105,0	2517	334,00
TB 10 PL 258	10	2	GG	258	53	53	46	105,0	2517	350,00
TB 10 PL 278	10	2	GG	278	53	53	46	105,0	2517	366,00
TB 10 PL 298	10	2	GG	298	53	53	46	105,0	2517	385,00
TB 10 PL 318	10	2	GG	318	53	53	46	105,0	2517	427,00
TB 10 PL 348	10	2	GG	348	53	53	46	105,0	2517	460,00
TB 10 PL 388	10	2	GG	388	53	53	46	105,0	2517	515,00
TB 12 PL 88	12	3	GG	88	62	62	26	70,0	1610	105,00
TB 12 PL 93	12	3	GG	93	62	62	26	70,0	1610	106,00
TB 12 PL 98	12	3	GG	98	62	62	26	70,0	1610	108,00
TB 12 PL 103	12	3	GG	103	62	62	33	85,0	2012	137,00
TB 12 PL 108	12	3	GG	108	62	62	33	85,0	2012	138,00
TB 12 PL 113	12	3	GG	113	62	62	33	85,0	2012	140,00
TB 12 PL 118	12	3	GG	118	62	62	33	85,0	2012	142,00
TB 12 PL 123	12	3	GG	123	62	62	33	85,0	2012	144,00
TB 12 PL 133	12	3	GG	133	62	62	33	85,0	2012	149,00
TB 12 PL 148	12	2	GG	148	62	62	46	105,0	2517	167,00
TB 12 PL 158	12	2	GG	158	62	62	46	105,0	2517	174,00
TB 12 PL 168	12	2	GG	168	62	62	46	105,0	2517	182,00
TB 12 PL 178	12	2	GG	178	62	62	46	105,0	2517	187,00
TB 12 PL 188	12	2	GG	188	62	62	46	105,0	2517	193,00
TB 12 PL 198	12	2	GG	198	62	62	46	105,0	2517	200,00
TB 12 PL 218	12	2	GG	218	62	62	46	105,0	2517	213,00
TB 12 PL 238	12	2	GG	238	62	62	52	130,0	3020	453,00
TB 12 PL 258	12	2	GG	258	62	62	52	130,0	3020	559,00
TB 12 PL 278	12	2	GG	278	62	62	52	130,0	3020	576,00
TB 12 PL 298	12	2	GG	298	62	62	52	130,0	3020	596,00
TB 12 PL 318	12	2	GG	318	62	62	52	130,0	3020	638,00
TB 12 PL 348	12	2	GG	348	62	62	52	130,0	3020	674,00
TB 12 PL 388	12	2	GG	388	62	62	52	130,0	3020	729,00

Taper-Buchse Taper bush	1610	2012	2517	3020
Bohrung $d_2$ (mm) von ... bis ... Bore $d_2$ (mm) from ... to ...	14-42	14-50	16-60	25-75
€/Stück each	12,40	15,20	19,10	24,80

GG = Grauguss Cast iron  
 Weitere Abmessungen auf Anfrage.  
 Further sizes on request.  
 Fertigungstechnische Änderungen vorbehalten.  
 We reserve the right to make technical changes.  
 Bohrungsdurchmesser  $d_2$  siehe Seite 3.  
 Bore diameters  $d_2$  see page 3.

**optibelt RBS** Keilrippenscheiben für Taper-Buchsen, Profil PL (keine Lagerware)  
**Ribbed belt pulleys for taper bushes, section PL (non stock items)**

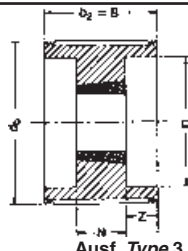

Ausf. Type 3

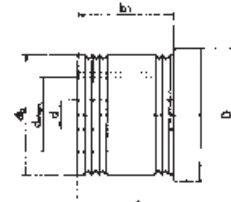

Ausf. Type VB (für zyl. Bohrung for plain boring)

Bezeichnung Part Number	Anzahl der Rillen No. of ribs	Aus- führung Type	Material	d <sub>b</sub> (mm)	b <sub>2</sub> (mm)	B (mm)	N (mm)	D (mm)	Taper- Buchse Taper bush	€ Stück ohne Buchse each without bush
TB 16 PL 103	16	3	GG	103	80	80	33	85,0	2012	141,00
TB 16 PL 108	16	3	GG	108	80	80	33	85,0	2012	143,00
TB 16 PL 113	16	3	GG	113	80	80	33	85,0	2012	144,00
TB 16 PL 118	16	3	GG	118	80	80	33	85,0	2012	148,00
TB 16 PL 123	16	3	GG	123	80	80	33	85,0	2012	150,00
TB 16 PL 133	16	3	GG	133	80	80	33	85,0	2012	153,00
TB 16 PL 148	16	3	GG	148	80	80	46	105,0	2517	172,00
TB 16 PL 158	16	3	GG	158	80	80	46	105,0	2517	185,00
TB 16 PL 168	16	3	GG	168	80	80	46	105,0	2517	192,00
TB 16 PL 178	16	3	GG	178	80	80	46	105,0	2517	198,00
TB 16 PL 188	16	3	GG	188	80	80	46	105,0	2517	205,00
TB 16 PL 198	16	3	GG	198	80	80	46	105,0	2517	211,00
TB 16 PL 218	16	3	GG	218	80	80	46	105,0	2517	227,00
TB 16 PL 238	16	3	GG	238	80	80	52	130,0	3020	470,00
TB 16 PL 258	16	3	GG	258	80	80	52	130,0	3020	483,00
TB 16 PL 278	16	3	GG	278	80	80	52	130,0	3020	498,00
TB 16 PL 298	16	3	GG	298	80	80	52	130,0	3020	516,00
TB 16 PL 318	16	3	GG	318	80	80	52	130,0	3020	553,00
TB 16 PL 348	16	3	GG	348	80	80	52	130,0	3020	585,00
TB 16 PL 388	16	3	GG	388	80	80	52	130,0	3020	634,00

Taper-Buchse Taper bush	2012	2517	3020
Bohrung d <sub>2</sub> (mm) von ... bis ... Bore d <sub>2</sub> (mm) from ... to ...	14-50	16-60	25-75
€/Stück each	15,20	19,10	24,80

Bohrungsdurchmesser d<sub>2</sub> siehe Seite 3.  
 Bore diameters d<sub>2</sub> see page 3.

**optibelt RBS** Keilrippenscheiben mit zylindrischer Bohrung, Profil PJ  
**Ribbed belt pulleys for plain boring, section PJ**

Bezeichnung Part Number	Anzahl der Rillen No. of ribs	Aus- führung Type	Material	d <sub>b</sub> (mm)	b <sub>1</sub> (mm)	B (mm)	D (mm)	Vorbohrung Pilot bore d (mm)	Fertig- bohrung Finish bore d <sub>max</sub> (mm)	Gewicht Weight (≈ kg)	€ Stück each
4 PJ 22,5	4	VB	GG	22,5	13	20	25	8	12,0	0,045	20,50
4 PJ 27,5	4	VB	GG	27,5	13	20	30	8	14,0	0,070	21,80
4 PJ 32,5	4	VB	GG	32,5	13	20	35	8	18,0	0,100	23,00
4 PJ 37,5	4	VB	GG	37,5	13	20	40	8	20,0	0,135	24,30
4 PJ 42,5	4	VB	GG	42,5	13	20	45	8	22,0	0,180	26,90
8 PJ 22,5	8	VB	GG	22,5	23	30	25	8	12,0	0,063	21,80
8 PJ 27,5	8	VB	GG	27,5	23	30	30	8	14,0	0,100	23,00
8 PJ 32,5	8	VB	GG	32,5	23	30	35	8	18,0	0,150	24,80
8 PJ 37,5	8	VB	GG	37,5	23	30	40	8	20,0	0,200	27,40
8 PJ 42,5	8	VB	GG	42,5	23	30	45	8	22,0	0,265	29,80
12 PJ 22,5	12	VB	GG	22,5	32	40	25	8	12,0	0,086	23,70
12 PJ 27,5	12	VB	GG	27,5	32	40	30	8	14,0	0,140	25,50
12 PJ 32,5	12	VB	GG	32,5	32	40	35	8	18,0	0,200	27,40
12 PJ 37,5	12	VB	GG	37,5	32	40	40	8	20,0	0,280	29,20
12 PJ 42,5	12	VB	GG	42,5	32	40	45	8	22,0	0,360	32,40

GG = Grauguss Cast iron

Weitere Abmessungen auf Anfrage. Further sizes on request.

Fertigungstechnische Änderungen vorbehalten. We reserve the right to make technical changes.

**optibelt F5** Flachriemenscheiben für Taper-Buchsen (keine Lagerware)  
*Flat belt pulleys for taper bushes (non stock items)*



Außendurchmesser x Breite Outside diameter x width (mm)	Taper-Buchse Taper bush	€ Stück ohne Buchse each without bush	Außendurchmesser x Breite Outside diameter x width (mm)	Taper-Buchse Taper bush	€ Stück ohne Buchse each without bush
63 x 50	1108	47,70	224 x 50	2517	126,00
80 x 50	1210	53,70	224 x 80	2517	191,00
80 x 80	1615	65,90	224 x 100	3020	220,00
90 x 50	1615	71,10	224 x 125	3030	252,00
90 x 80	1615	74,50	224 x 160	3030	291,00
90 x 100	1615	85,00	250 x 80	2517	211,00
100 x 50	1615	78,90	250 x 100	3020	244,00
100 x 80	1615	90,20	250 x 125	3030	286,00
100 x 100	1615	104,00	250 x 160	3030	330,00
125 x 50	2012	92,80	280 x 100	3020	277,00
125 x 80	2517	111,00	280 x 125	3030	324,00
125 x 100	2517	128,00	280 x 160	3535	380,00
125 x 125	2517	133,00	280 x 200	4040	450,00
140 x 50	2012	107,00	315 x 100	3020	307,00
140 x 80	2517	119,00	315 x 125	3030	387,00
140 x 100	3020	141,00	315 x 160	3535	441,00
140 x 125	3030	149,00	315 x 200	4040	527,00
150 x 50	2012	113,00	355 x 100	3030	354,00
150 x 80	2517	128,00	355 x 125	3030	431,00
150 x 100	3020	150,00	355 x 160	3535	515,00
150 x 125	3030	156,00	355 x 200	4040	608,00
150 x 160	3030	174,00	400 x 100	3535	454,00
160 x 50	2012	119,00	400 x 125	3535	515,00
160 x 80	2517	137,00	400 x 160	3535	596,00
160 x 100	3020	158,00	400 x 200	4040	704,00
160 x 125	3030	161,00	450 x 160	3535	693,00
160 x 160	3030	193,00	450 x 200	4040	818,00
180 x 80	2517	153,00	500 x 160	4040	791,00
180 x 100	3020	178,00	500 x 200	4545	932,00
180 x 125	3030	190,00	560 x 160	4040	984,00
180 x 160	3030	223,00	560 x 200	4545	1.142,00
200 x 80	2517	169,00	630 x 160	4545	1.076,00
200 x 100	3020	195,00	630 x 200	5050	1.269,00
200 x 125	3030	219,00			
200 x 160	3030	252,00			

Taper-Buchse Taper bush	1108	1210	1615	2012	2517	3020	3030	3535	4040	4545	5050
Bohrung d <sub>2</sub> (mm) von ... bis ... Bore d <sub>2</sub> (mm) from ... to ...	10-28	11-32	14-42	14-50	16-60	25-75	35-75	35-90	40-100	55-110	70-125
€/Stück each	7,90	10,40	13,00	15,20	19,10	24,80	32,50	62,60	88,00	112,00	179,00

Bohrungsdurchmesser d<sub>2</sub> siehe Seite 3.  
 Bore diameters d<sub>2</sub> see page 3.

Material: EN-GJL 200 – DIN EN 1561  
 Material: EN-GJL 200 – DIN EN 1561

Fertigungstechnische Änderungen vorbehalten.  
 We reserve the right to make technical changes.

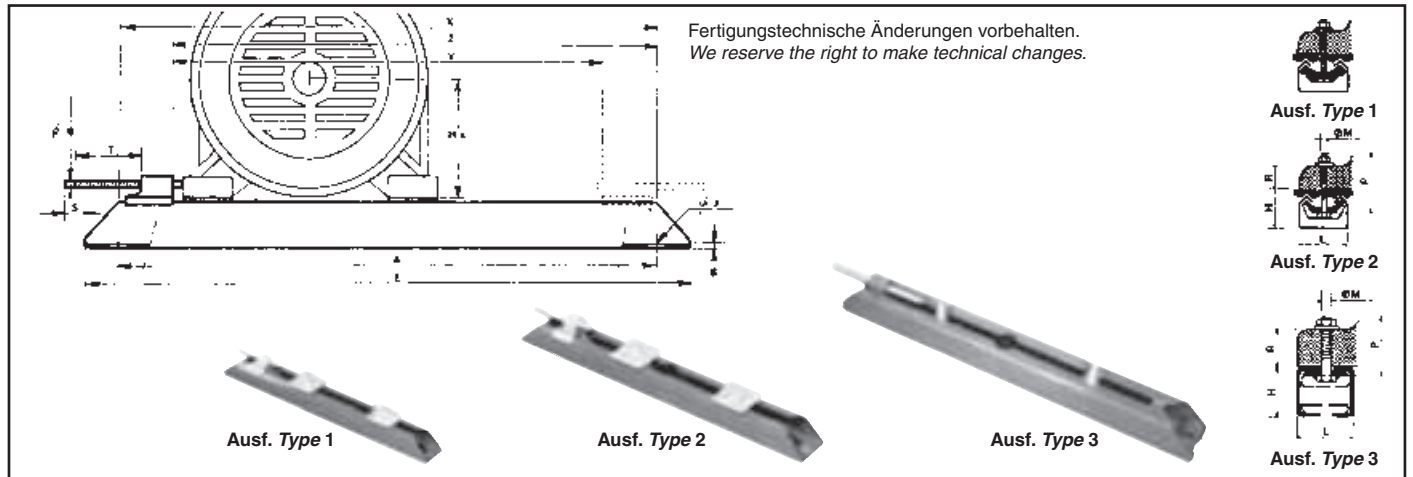

Bezeichnung Part number	S71/6VS	N300/6VS	S100/8VS	N400/8VS	S132/10VS	N600/10VS	S180/12VS	S225/16GS	S280/20GS	S355/24GS
Ausführung Type	1	1	2	2	2	2	2	3	3	3
Motorachshöhe Motor shaft centre height Ha (mm)	56/63/71	80	80/90/100	100/112	100/112/132	160	160/180	200/225	250/280	315/355
Abmessungen Dimensions	A (mm)	280,0	343,0	355,0	455,0	480,0	580,0	630,0	800,0	1000,0
	E (mm)	312,0	375,0	395,0	495,0	530,0	630,0	686,0	864,0	1072,0
	H (mm)	28,0	28,0	40,0	40,0	49,5	49,5	60,5	75,0	100,0
	Ø J (mm)	10,5	10,5	13,0	13,0	15,0	15,0	19,0	24,0	30,0
	K (mm)	1,5	1,5	2,5	2,5	7,0	7,0	7,0	28,5	35,0
	L (mm)	40,2	40,2	50,0	50,0	60,0	60,0	75,0	90,0	112,0
	Ø M (mm)	6,0	6,0	8,0	8,0	10,0	10,0	12,0	16,0	20,0
	P (mm)	35,0	35,0	45,0	45,0	55,0	55,0	70,0	70,0	80,0
	R (mm)	13,0	13,0	18,5	18,5	23,5	23,5	34,0	41,0	48,0
	S (mm)	20,0	20,0	30,0	32,0	37,0	37,0	50,0	167,0	200,0
T (mm)	75,0	75,0	97,0	97,0	119,0	119,0	154,0	300,0	360,0	
□ U (mm)	6,0	6,0	8,0	8,0	9,0	9,0	12,0	16,0	19,0	
Nutzlänge Working length	X (mm)	262,0	325,0	324,0	424,0	442,0	542,0	—	—	—
	Y (mm)	206,0	265,0	264,0	354,0	368,0	473,0	623,0	764,0	946,0
	Z (mm)	234,0	295,0	294,0	394,0	405,0	502,5	698,0	864,0	1064,0
Gewicht je Paar Weight per pair (= kg)	1,120	1,300	2,970	3,500	6,100	6,500	10,650	16,200	36,100	59,500
<b>€/Satz set</b>	<b>76,50</b>	<b>94,10</b>	<b>110,00</b>	<b>128,00</b>	<b>163,00</b>	<b>177,00</b>	<b>254,00</b>	<b>541,00</b>	<b>855,00</b>	<b>1.274,00</b>

### Vorteile der Optibelt MS Motorspannschienen

- Sie sind unzerbrechlich, weil sie ganz aus Stahl hergestellt sind.
- Die genormten Motorbefestigungsschrauben sind leicht auswechselbar, z. B. bei starken Motorfüßen oder bei zu befestigenden Zusatzteilen.
- Leichtes Aufsetzen des Motors:  
Nach dem Einstecken der Motorbefestigungsschrauben in die Motorfüße wird das Ganze mit den Spezialmuttern in die Stahlspannschienen eingeschoben.
- Alle Einzelteile sind bestens gegen Korrosion durch entsprechende Oberflächenbehandlung geschützt.
- Stahlspannschienen: phosphatiert und grün einbrennlackiert.
- Spannschrauben: elektro-verzinkt.
- Motorbefestigungsschrauben:  
für S 71 bis S 180 elektro-verzinkt,  
für S 225 bis S 355 phosphatiert und mit Rostschutz versehen.

Die mit „S“ gekennzeichneten Abmessungen (z. B. S 71) entsprechen der französischen Norm U.T.E. C-51106.

Die Zahlen 71, 100, 132, 180, 225, 280 und 355 bezeichnen die maximalen Motorachshöhen in mm für den jeweiligen Spannschienen-Typ.

Die Zahlen hinter dem Schrägstrich (6, 8, 10, 12, 16, 20, 24) geben den Gewindedurchmesser der entsprechenden Befestigungsschrauben an (6 = M6).

Die Buchstaben VS bzw. GS bezeichnen die Ausführung der Spannkloben:

VS = verschiebbarer Spannkloben

GS = geschweißter Spannkloben

Die Typen N 300, N 400 und N 600 sind nicht genormt. Es handelt sich jeweils um die verlängerte Ausführung der genormten Schiene, sodass hierfür die gleichen Ersatzteile verwendet werden können.

Ein Satz Spannschienen besteht aus 2 Schienen inklusive aller Befestigungsteile.

### Advantages of Optibelt MS Motor slide rails

- Rugged all steel construction.
- The standard motor fixing bolts are easily replaced, e. g. for heavier motor feet or for the mounting of auxiliary equipment.
- Easy motor mounting. After inserting the motor mounting bolts into the motor feet, the whole unit is pushed into the rails.
- All parts are fully corrosion protected.
- The adjusting bolts are zinc plated.
- The motor mounting bolts:  
for S 71 up to S 180 are zinc plated,  
for S 225 up to S 355 are phosphated and rust protected.

The sizes marked with "S" (e. g. S 71) correspond to the French standard U.T.E. C-51106.

The numbers 71, 100, 132, 180, 225, 280, and 355 indicate the max. motor shaft height in mm for the individual rail types.

The numbers following the slash (6, 8, 10, 12, 16, 20, 24) indicate the thread diameters of the fixing bolts (6 = M6).

The letters VS and GS indicate the design of the adjusting screw bracket:

VS = sliding bracket

GS = fixed bracket

Slide rail part number N 300, N 400, and N 600 are not standardised. They are longer than the standard slide rails but all of the same spare parts can be used.

One set of slide rails consists of 2 rails with all fixing parts.

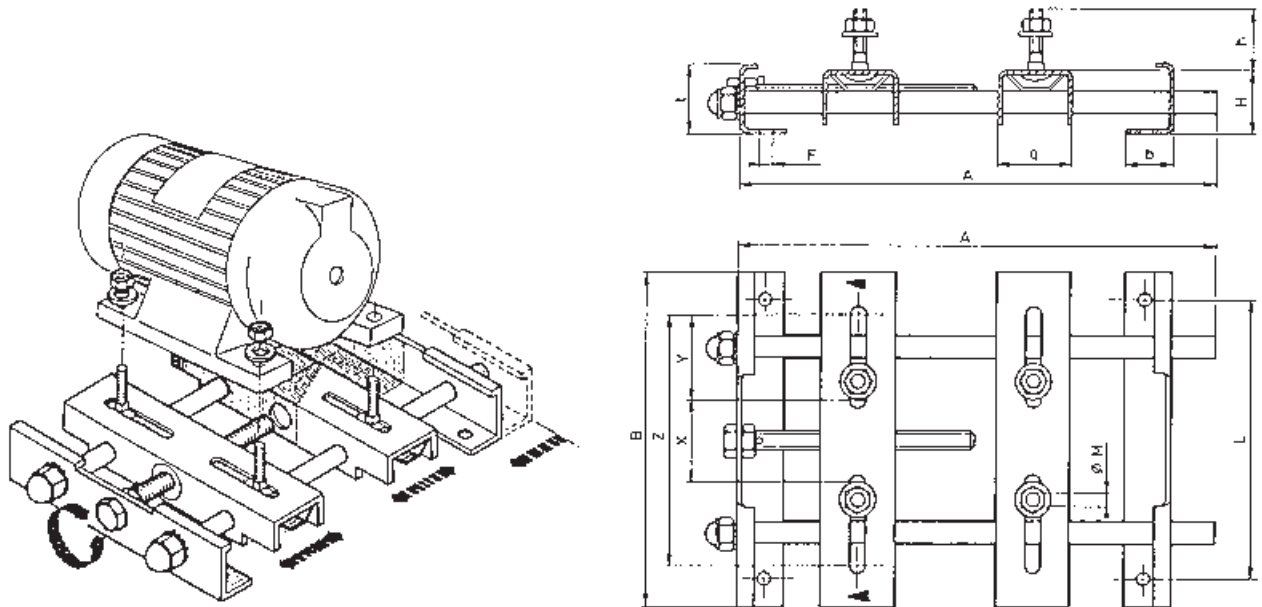

Fertigungstechnische Änderungen vorbehalten. We reserve the right to make technical changes.

Bezeichnung Part number	MS 100	MS 132
Motorachshöhe Motor shaft height Ha (mm)	100,0	132,0
A (mm)	300,0	450,0
B (mm)	180,0	265,0
F (mm)	10,0	13,0
H (mm)	35,0	50,0
L (mm)	150,0	225,0
M	M 8 x 35	M 10 x 40
b (mm)	30,0	45,0
g (mm)	40,0	55,0
h (mm)	35,0	40,0
t (mm)	40,0	55,0
u (mm)	25,0	35,0
v (mm)	20,0	25,0
w (mm)	9,0	18,0
x (mm)	46,0	105,0
y (mm)	50,0	50,0
z (mm)	145,0	204,0
Gewicht Weight ( $\approx$ kg)	2,180	4,520
€/Stück each	121,00	193,00

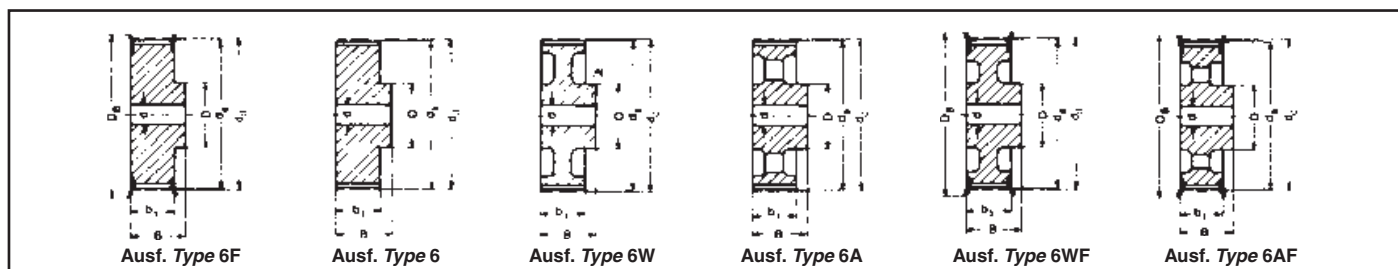

**Type XL – Teilung Pitch 5,08 mm für Riemenbreite for belt width 025, 031, 037**

Bezeichnung Part No.	Anzahl der Zähne No. of teeth	Aus- führung Type	Material	d <sub>d</sub> (mm)	d <sub>a</sub> (mm)	D <sub>B</sub> (mm)	b <sub>1</sub> (mm)	B (mm)	D (mm)	Vor- bohrung Pilot bore d (mm)	Fertig- bohrung Finished bore d <sub>max</sub> (mm)	Stell- schraube Grub screw	Gewicht Weight (= kg)	€ Stück each
10 XL 037	10	6F	St	16,17	15,66	23	14,3	19,8	9,5	5,0	6,4	M3	0,02	9,80
11 XL 037	11	6F	St	17,79	17,28	23	14,3	19,8	9,5	5,0	6,4	M3	0,02	10,20
12 XL 037	12	6F	St	19,40	18,89	25	14,3	19,8	12,7	5,0	7,9	M3	0,03	10,50
14 XL 037	14	6F	St	22,64	22,13	28	14,3	19,8	14,3	6,0	9,5	M4	0,04	10,80
15 XL 037	15	6F	St	24,26	23,75	28	14,3	19,8	15,9	6,0	11,1	M4	0,04	11,30
16 XL 037	16	6F	St	25,87	25,36	32	14,3	19,8	17,5	6,0	12,7	M4	0,05	11,60
18 XL 037	18	6F	St	29,11	28,60	36	14,3	19,8	19,0	6,0	14,3	M4	0,06	12,00
20 XL 037	20	6F	St	32,34	31,83	38	14,3	22,2	23,8	6,0	17,5	M4	0,08	12,30
21 XL 037	21	6F	St	33,96	33,45	38	14,3	22,2	23,8	6,0	17,5	M4	0,09	12,60
22 XL 037	22	6F	St	35,57	35,06	42	14,3	22,2	25,4	6,0	19,1	M4	0,10	13,10
24 XL 037	24	6F	St	38,81	38,30	44	14,3	22,2	27,0	6,0	20,6	M4	0,12	14,40
26 XL 037	26	6F	St	42,04	41,53	48	14,3	22,2	30,0	6,0	23,0	M4	0,14	15,20
28 XL 037	28	6F	St	45,28	44,77	51	14,3	22,2	30,2	6,0	23,0	M4	0,16	15,60
30 XL 037	30	6F	St	48,51	48,00	54	14,3	22,2	34,9	6,0	23,0	M4	0,19	15,90
32 XL 037	32	6	Al	51,74	51,23	—	14,3	25,4	38,0	8,0	23,0	M4	0,11	17,40
36 XL 037	36	6	Al	58,21	57,70	—	14,3	25,4	38,0	8,0	23,0	M4	0,13	18,90
40 XL 037	40	6	Al	64,68	64,17	—	14,3	25,4	38,0	8,0	23,0	M4	0,17	20,30
42 XL 037	42	6W	Al	67,91	67,40	—	14,3	25,4	38,0	8,0	23,0	M4	0,13	24,30
44 XL 037	44	6W	Al	71,15	70,64	—	14,3	25,4	38,0	8,0	23,0	M4	0,15	25,70
48 XL 037	48	6W	Al	77,62	77,11	—	14,3	25,4	38,0	8,0	23,0	M4	0,16	27,20
60 XL 037	60	6A	Al	97,02	96,51	—	14,3	25,4	38,0	8,0	23,0	M4	0,18	30,50
72 XL 037	72	6A	Al	116,43	115,92	—	14,3	25,4	38,0	8,0	23,0	M4	0,23	35,90

**Type L – Teilung Pitch 9,525 mm für Riemenbreite for belt width 050**

10 L 050	10	6F	St	30,32	29,56	36	19	26	22	6,0	13,0	—	0,11	10,80
12 L 050	12	6F	St	36,38	35,62	42	19	26	28	6,0	17,0	—	0,19	12,00
13 L 050	13	6F	St	39,41	38,65	44	19	26	30	6,0	19,0	—	0,21	12,30
14 L 050	14	6F	St	42,45	41,68	48	19	26	33	8,0	20,0	—	0,25	13,10
15 L 050	15	6F	St	45,48	44,72	51	19	26	36	8,0	23,0	—	0,30	14,40
16 L 050	16	6F	St	48,51	47,75	54	19	26	38	8,0	23,0	—	0,33	15,20
17 L 050	17	6F	St	51,54	50,78	57	19	26	40	10,0	24,0	—	0,36	15,90
18 L 050	18	6F	St	54,57	53,81	60	19	26	40	10,0	24,0	—	0,41	17,00
19 L 050	19	6F	St	57,61	56,84	60	19	26	40	10,0	24,0	—	0,45	17,70
20 L 050	20	6F	St	60,64	59,88	66	19	26	46	10,0	28,0	—	0,50	18,50
21 L 050	21	6F	St	63,67	62,91	71	19	26	46	10,0	28,0	—	0,55	18,90
22 L 050	22	6F	St	66,70	65,94	75	19	26	50	10,0	30,0	—	0,62	19,20
24 L 050	24	6F	St	72,77	72,00	79	19	26	50	12,0	30,0	—	0,68	20,30
26 L 050	26	6F	St	78,83	78,07	87	19	26	50	12,0	30,0	—	0,82	23,10
28 L 050	28	6F	St	84,89	84,13	91	19	26	50	12,0	30,0	—	0,92	24,60
30 L 050	30	6F	St	90,96	90,20	97	19	26	50	12,0	30,0	—	1,10	25,70
32 L 050	32	6F	St	97,02	96,26	103	19	26	50	12,0	30,0	—	1,20	27,90
36 L 050	36	6WF	GG	109,15	108,38	115	19	26	50	12,0	30,0	—	1,00	32,60
40 L 050	40	6WF	GG	121,28	120,51	127	19	26	50	12,0	30,0	—	1,10	36,60
44 L 050	44	6AF	GG	133,40	132,64	140	19	26	50	12,0	30,0	—	1,20	40,20
48 L 050	48	6AF	GG	145,53	144,77	152	19	26	50	12,0	30,0	—	1,30	44,30
60 L 050	60	6A	GG	181,91	181,15	—	19	28	50	15,0	30,0	—	1,30	45,70
72 L 050	72	6A	GG	218,30	217,53	—	19	28	50	15,0	30,0	—	1,70	52,60
84 L 050	84	6A	GG	254,68	253,92	—	19	28	50	15,0	30,0	—	1,90	59,40

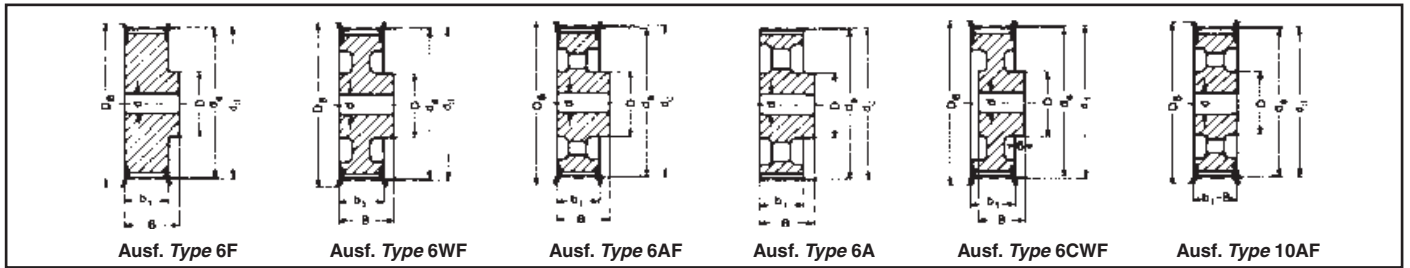

**Type L – Teilung Pitch 9,525 mm für Riemenbreite for belt width 075**

Bezeichnung Part No.	Anzahl der Zähne No. of teeth	Aus- führung Type	Material	d <sub>d</sub> (mm)	d <sub>a</sub> (mm)	D <sub>B</sub> (mm)	b <sub>1</sub> (mm)	B (mm)	D (mm)	Vor- bohrung Pilot bore d (mm)	Fertig- bohrung Finished bore d <sub>max</sub> (mm)	Gewicht Weight (= kg)	€ Stück each
10 L 075	10	6F	St	30,32	29,56	36	25	32	22	6	13	0,15	12,00
12 L 075	12	6F	St	36,38	35,62	42	25	32	28	8	17	0,23	12,60
13 L 075	13	6F	St	39,41	38,65	44	25	32	30	8	19	0,26	13,80
14 L 075	14	6F	St	42,45	41,68	48	25	32	33	8	20	0,32	15,20
15 L 075	15	6F	St	45,48	44,72	51	25	32	36	8	23	0,35	15,90
16 L 075	16	6F	St	48,51	47,75	54	25	32	38	8	23	0,42	16,70
17 L 075	17	6F	St	51,54	50,78	57	25	32	40	10	24	0,45	17,70
18 L 075	18	6F	St	54,57	53,81	60	25	32	40	10	24	0,51	18,90
19 L 075	19	6F	St	57,61	56,84	60	25	32	40	10	24	0,57	19,50
20 L 075	20	6F	St	60,64	59,88	66	25	32	46	10	28	0,63	20,30
21 L 075	21	6F	St	63,67	62,91	71	25	32	46	10	28	0,70	20,70
22 L 075	22	6F	St	66,70	65,94	75	25	32	50	10	30	0,75	21,00
24 L 075	24	6F	St	72,77	72,00	79	25	32	50	12	30	0,85	23,10
26 L 075	26	6F	St	78,83	78,07	87	25	32	50	12	30	1,00	25,40
28 L 075	28	6F	St	84,89	84,13	91	25	32	50	12	30	1,20	26,10
30 L 075	30	6F	St	90,96	90,20	97	25	32	50	12	30	1,40	29,00
32 L 075	32	6F	St	97,02	96,26	103	25	32	50	12	30	1,50	30,50
36 L 075	36	6WF	GG	109,15	108,38	115	25	32	55	12	32	1,30	36,60
40 L 075	40	6WF	GG	121,28	120,51	127	25	32	60	12	35	1,60	43,10
44 L 075	44	6AF	GG	133,40	132,64	140	25	32	60	12	35	1,70	47,50
48 L 075	48	6AF	GG	145,53	144,77	152	25	32	60	12	35	1,90	52,60
60 L 075	60	6A	GG	181,91	181,15	—	26	35	60	15	35	1,80	55,40
72 L 075	72	6A	GG	218,30	217,53	—	26	35	60	15	35	2,30	61,60
84 L 075	84	6A	GG	254,68	253,92	—	26	35	60	15	35	2,50	71,00

**Type L – Teilung Pitch 9,525 mm für Riemenbreite for belt width 100**

10 L 100	10	6F	St	30,32	29,56	36	31	38	22	6	13	0,81	13,10
12 L 100	12	6F	St	36,38	35,62	42	31	38	28	8	17	0,29	13,80
13 L 100	13	6F	St	39,41	38,65	44	31	38	30	8	19	0,30	15,20
14 L 100	14	6F	St	42,45	41,68	48	31	38	33	8	20	0,38	16,40
15 L 100	15	6F	St	45,48	44,72	51	31	38	36	8	23	0,40	17,00
16 L 100	16	6F	St	48,51	47,75	54	31	38	38	8	23	0,51	17,70
17 L 100	17	6F	St	51,54	50,78	57	31	38	40	10	24	0,54	18,90
18 L 100	18	6F	St	54,57	53,81	60	31	38	40	10	24	0,62	19,50
19 L 100	19	6F	St	57,61	56,84	60	31	38	40	10	24	0,69	20,70
20 L 100	20	6F	St	60,64	59,88	66	31	38	46	10	28	0,76	21,30
21 L 100	21	6F	St	63,67	62,91	71	31	38	46	10	28	0,82	22,80
22 L 100	22	6F	St	66,70	65,94	75	31	38	50	10	30	0,92	24,30
24 L 100	24	6F	St	72,77	72,00	79	31	38	50	12	30	1,10	25,70
26 L 100	26	6F	St	78,83	78,07	87	31	38	50	12	30	1,30	27,20
28 L 100	28	6F	St	84,89	84,13	91	31	38	50	12	30	1,40	29,30
30 L 100	30	6F	St	90,96	90,20	97	31	38	50	12	30	1,70	31,50
32 L 100	32	6F	St	97,02	96,26	103	31	38	50	12	30	1,80	33,70
36 L 100	36	6CWF	GG	109,15	108,38	115	32	32	55	12	32	1,50	40,20
40 L 100	40	6CWF	GG	121,28	120,51	127	32	32	60	12	35	1,80	44,30
44 L 100	44	10AF	GG	133,40	132,64	140	32	32	60	12	35	1,90	53,30
48 L 100	48	10AF	GG	145,53	144,77	152	32	32	60	12	35	2,10	56,20
60 L 100	60	6A	GG	181,91	181,15	—	32	35	60	15	35	2,00	57,60
72 L 100	72	6A	GG	218,30	217,53	—	32	35	60	15	35	2,50	66,30
84 L 100	84	6A	GG	254,68	253,92	—	32	35	60	15	35	2,70	74,60

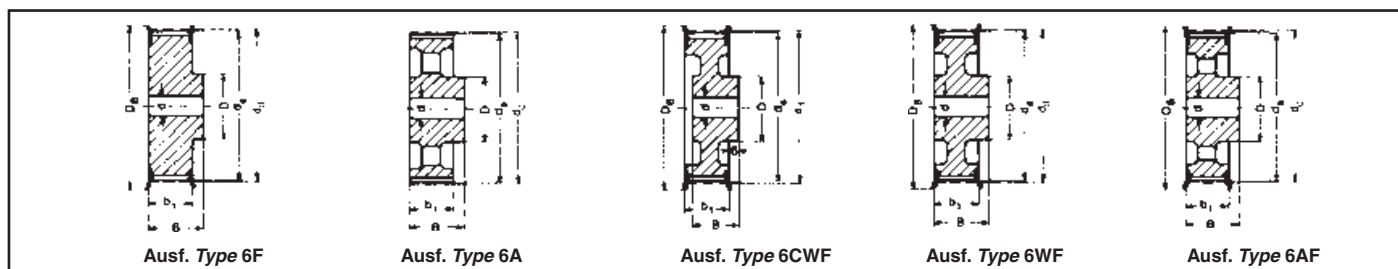

**Type H – Teilung Pitch 12,7 mm für Riemenbreite for belt width 075**

Bezeichnung Part No.	Anzahl der Zähne No. of teeth	Aus- führung Type	Material	d <sub>d</sub> (mm)	d <sub>a</sub> (mm)	D <sub>B</sub> (mm)	b <sub>1</sub> (mm)	B (mm)	D (mm)	Vor- bohrung Pilot bore d (mm)	Fertig- bohrung Finished bore d <sub>max</sub> (mm)	Gewicht Weight (= kg)	€ Stück each
14 H 075	14	6F	St	56,60	55,22	64,0	26,4	40	40	10	24	0,50	19,50
16 H 075	16	6F	St	64,67	63,31	70,0	26,4	40	46	10	26	0,60	21,00
18 H 075	18	6F	St	72,77	71,39	79,0	26,4	40	54	12	32	0,80	22,80
19 H 075	19	6F	St	76,81	75,44	82,5	26,4	40	58	12	35	1,00	24,30
20 H 075	20	6F	St	80,85	79,48	87,0	26,4	40	62	12	35	1,10	25,70
21 H 075	21	6F	St	84,89	83,52	91,0	26,4	40	67	12	38	1,20	26,40
22 H 075	22	6F	St	88,94	87,56	94,0	26,4	40	70	12	38	1,40	27,50
24 H 075	24	6F	St	97,02	95,65	102,0	26,4	40	75	12	42	1,60	30,80
26 H 075	26	6F	St	105,11	103,73	112,0	26,4	40	80	15	45	1,80	34,80
28 H 075	28	6F	GG	113,19	111,82	120,0	26,4	40	80	15	45	2,00	36,90
30 H 075	30	6F	GG	121,28	119,90	128,0	26,4	40	80	15	45	2,10	38,80
32 H 075	32	6F	GG	129,36	127,99	135,0	26,4	40	70	15	45	2,20	44,60
36 H 075	36	6F	GG	145,53	144,16	152,0	26,4	40	80	20	45	2,40	49,30
40 H 075	40	6F	GG	161,70	160,33	168,0	26,4	40	80	20	45	2,80	55,80
44 H 075	44	6AF	GG	177,87	176,50	184,0	26,4	40	80	20	45	2,70	59,00
48 H 075	48	6AF	GG	194,04	192,67	200,0	26,4	40	90	20	50	3,00	62,30

**Type H – Teilung Pitch 12,7 mm für Riemenbreite for belt width 100**

14 H 100	14	6F	St	56,60	55,22	63	31	41	40	10	24	0,65	22,10
16 H 100	16	6F	St	64,68	63,31	71	31	41	46	10	28	0,85	24,30
18 H 100	18	6F	St	72,77	71,39	79	31	41	54	12	32	1,10	26,10
19 H 100	19	6F	St	76,81	75,44	83	31	41	58	12	34	1,20	27,50
20 H 100	20	6F	St	80,85	79,48	87	31	41	62	12	35	1,40	29,00
21 H 100	21	6F	St	84,89	83,52	91	31	41	67	12	38	1,60	30,00
22 H 100	22	6F	St	88,94	87,56	93	31	41	70	12	41	1,70	31,20
24 H 100	24	6F	St	97,02	95,65	103	31	41	75	12	45	2,00	35,10
26 H 100	26	6CWF	GG	105,11	103,73	111	32	32	55	15	32	1,40	39,50
28 H 100	28	6CWF	GG	113,19	111,82	119	32	32	60	15	35	1,60	41,60
30 H 100	30	6CWF	GG	121,28	119,90	127	32	32	60	15	35	1,70	44,30
32 H 100	32	6WF	GG	129,36	127,99	135	32	40	70	20	40	2,20	50,30
36 H 100	36	6WF	GG	145,53	144,16	152	32	40	80	20	45	3,00	56,20
40 H 100	40	6AF	GG	161,70	160,33	168	32	40	80	20	45	2,80	63,40
44 H 100	44	6AF	GG	177,87	176,50	184	32	40	80	20	45	3,10	67,00
48 H 100	48	6AF	GG	194,04	192,67	200	32	40	80	20	45	3,30	71,00
60 H 100	60	6A	GG	242,55	241,18	—	34	45	80	20	45	5,50	87,70
72 H 100	72	6A	GG	291,06	289,69	—	34	45	80	20	45	7,10	117,00
84 H 100*	84	6A	GG	339,57	338,20	—	34	45	80	20	45	8,20	141,00
96 H 100*	96	6A	GG	388,08	386,71	—	34	45	80	20	45	9,90	168,00
120 H 100*	120	6A	GG	485,10	483,73	—	34	50	90	20	50	13,10	231,00



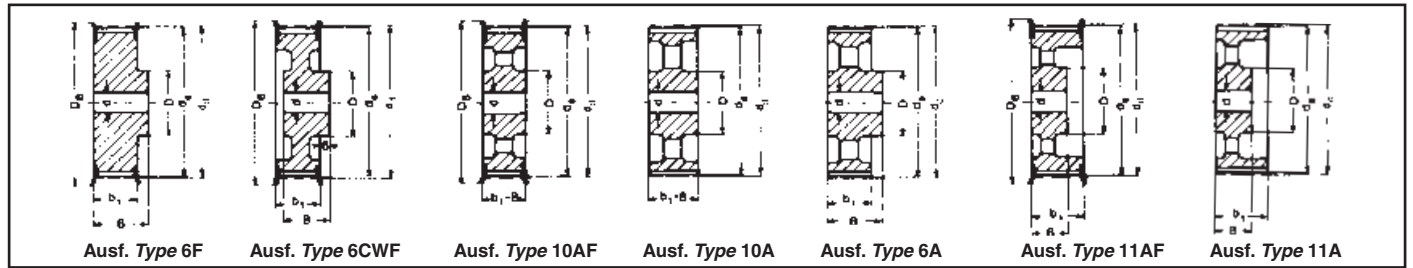

**Type H – Teilung Pitch 12,7 mm für Riemenbreite for belt width 150**

Bezeichnung Part No.	Anzahl der Zähne No. of teeth	Aus- führung Type	Material	d <sub>d</sub> (mm)	d <sub>a</sub> (mm)	D <sub>B</sub> (mm)	b <sub>1</sub> (mm)	B (mm)	D (mm)	Vor- bohrung Pilot bore d (mm)	Fertig- bohrung Finished bore d <sub>max</sub> (mm)	Gewicht Weight (= kg)	€ Stück each
14 H 150	14	6F	St	56,60	55,22	63	44	54	40	12	24	0,82	26,10
16 H 150	16	6F	St	64,68	63,31	71	44	54	46	12	28	1,10	28,70
18 H 150	18	6F	St	72,77	71,39	79	44	54	54	12	32	1,50	31,20
19 H 150	19	6F	St	76,81	75,44	83	44	54	58	12	34	1,70	33,70
20 H 150	20	6F	St	80,85	79,48	87	44	54	62	12	35	1,80	35,60
21 H 150	21	6F	St	84,89	83,52	91	44	54	67	12	38	2,20	37,70
22 H 150	22	6F	St	88,94	87,56	93	44	54	70	12	41	2,30	40,20
24 H 150	24	6F	St	97,02	95,65	103	44	54	75	12	45	2,60	42,80
26 H 150	26	6CWF	GG	105,11	103,73	111	45	35	55	15	32	1,70	44,90
28 H 150	28	6CWF	GG	113,19	111,82	119	45	35	60	15	35	1,90	47,90
30 H 150	30	6CWF	GG	121,28	119,90	127	45	35	60	15	35	2,10	50,70
32 H 150	32	6CWF	GG	129,36	127,99	135	45	45	70	20	40	2,60	56,50
36 H 150	36	6CWF	GG	145,53	144,16	152	45	45	80	20	45	3,20	64,10
40 H 150	40	10AF	GG	161,70	160,33	168	45	45	80	20	45	3,80	75,40
44 H 150	44	10AF	GG	177,87	176,50	184	45	45	80	20	45	3,70	79,70
48 H 150	48	10AF	GG	194,04	192,67	200	45	45	80	20	45	4,00	83,30
60 H 150	60	10A	GG	242,55	241,18	—	46	46	85	20	48	5,10	109,00
72 H 150	72	10A	GG	291,06	289,69	—	46	46	85	20	48	7,90	132,00
84 H 150*	84	10A	GG	339,57	338,20	—	46	46	85	20	48	8,90	165,00
96 H 150*	96	10A	GG	388,08	386,71	—	46	46	85	20	48	10,10	188,00
120 H 150*	120	6A	GG	485,10	483,73	—	46	55	95	24	55	17,20	270,00

**Type H – Teilung Pitch 12,7 mm für Riemenbreite for belt width 200**

14 H 200	14	6F	St	56,60	55,22	63	58	68	40	12	24	1,1	29,70
16 H 200	16	6F	St	64,68	63,31	71	58	68	46	15	28	1,4	33,70
18 H 200	18	6F	St	72,77	71,39	79	58	68	54	15	32	1,8	36,60
19 H 200	19	6F	St	76,81	75,44	83	58	68	58	15	34	2,1	38,80
20 H 200	20	6F	St	80,85	79,48	87	58	68	62	15	35	2,3	40,20
21 H 200	21	6F	St	84,89	83,52	91	58	68	67	15	38	2,6	42,80
22 H 200	22	6F	St	88,94	87,56	93	58	68	70	15	41	2,8	44,90
24 H 200	24	6F	St	97,02	95,65	103	58	68	75	15	45	3,4	49,30
26 H 200	26	6CWF	GG	105,11	103,73	111	58	42	60	15	35	2,3	51,50
28 H 200	28	6CWF	GG	113,19	111,82	119	58	42	60	15	35	2,5	55,40
30 H 200	30	6CWF	GG	121,28	119,90	127	58	42	70	15	40	2,9	59,00
32 H 200	32	6CWF	GG	129,36	127,99	135	58	47	70	20	40	3,2	61,60
36 H 200	36	6CWF	GG	145,53	144,16	152	58	47	80	20	45	3,8	71,80
40 H 200	40	11AF	GG	161,70	160,33	168	58	45	80	20	45	4,1	87,70
44 H 200	44	11AF	GG	177,87	176,50	184	58	45	80	20	45	4,4	94,90
48 H 200	48	11AF	GG	194,04	192,67	200	58	45	85	20	48	5,1	101,00
60 H 200	60	11A	GG	242,55	241,18	—	60	50	90	20	50	7,1	129,00
72 H 200	72	11A	GG	291,06	289,69	—	60	50	90	20	50	8,0	169,00
84 H 200*	84	11A	GG	339,57	338,20	—	60	50	90	20	50	12,0	201,00
96 H 200*	96	11A	GG	388,08	386,71	—	60	50	90	20	50	13,6	229,00
120 H 200*	120	10A	GG	485,10	483,73	—	60	60	100	24	57	16,6	323,00

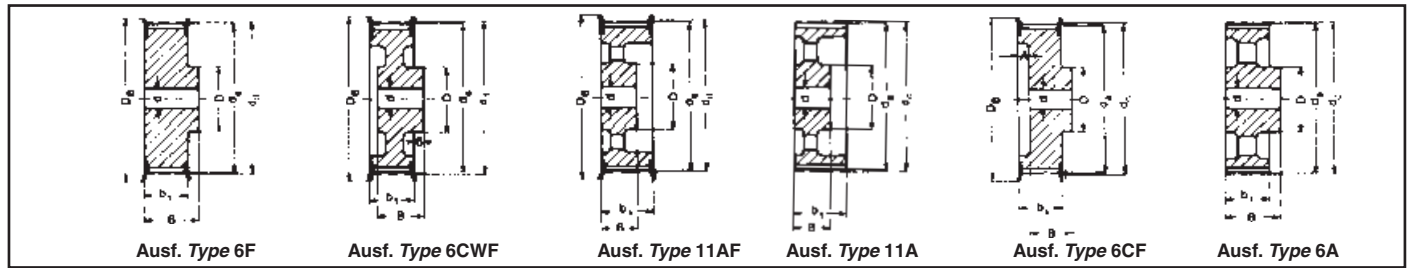

**Type H – Teilung Pitch 12,7 mm für Riemenbreite for belt width 300**

Bezeichnung Part No.	Anzahl der Zähne No. of teeth	Aus- führung Type	Material	d <sub>d</sub> (mm)	d <sub>a</sub> (mm)	D <sub>B</sub> (mm)	b <sub>1</sub> (mm)	B (mm)	D (mm)	A (mm)	Vor- bohrung Pilot bore d (mm)	Fertig- bohrung Finished bore d <sub>max</sub> (mm)	Gewicht Weight (= kg)	€ Stück each
16 H 300	16	6F	St	64,68	63,31	71	84	94	46	—	15	28	2,0	41,00
18 H 300	18	6F	St	72,77	71,39	79	84	94	54	—	15	32	2,6	44,90
19 H 300	19	6F	St	76,81	75,44	83	84	94	58	—	15	34	2,9	47,50
20 H 300	20	6F	St	80,85	79,48	87	84	94	62	—	15	35	3,2	49,70
21 H 300	21	6F	St	84,89	83,52	91	84	94	67	—	15	38	3,6	52,90
22 H 300	22	6F	St	88,94	87,56	93	84	94	70	—	15	41	4,0	55,80
24 H 300	24	6F	St	97,02	95,65	103	84	94	75	—	15	45	4,7	61,60
26 H 300	26	6CWF	GG	105,11	103,73	111	84	57	60	—	15	35	3,3	78,20
28 H 300	28	6CWF	GG	113,19	111,82	119	84	57	60	—	15	35	3,6	85,90
30 H 300	30	6CWF	GG	121,28	119,90	127	84	57	70	—	15	40	4,2	94,90
32 H 300	32	6CWF	GG	129,36	127,99	135	84	57	70	—	20	40	4,3	102,00
36 H 300	36	6CWF	GG	145,53	144,16	152	84	57	80	—	20	45	5,2	114,00
40 H 300	40	11AF	GG	161,70	160,33	168	84	55	80	—	20	45	5,6	121,00
44 H 300	44	11AF	GG	177,87	176,50	184	84	55	80	—	20	45	5,9	129,00
48 H 300	48	11AF	GG	194,04	192,67	200	84	55	85	—	20	48	6,6	138,00
60 H 300	60	11A	GG	242,55	241,18	—	86	55	100	—	20	57	9,9	174,00
72 H 300	72	11A	GG	291,06	289,69	—	86	55	100	—	20	57	13,0	225,00
84 H 300*	84	11A	GG	339,57	338,20	—	86	55	100	—	20	57	15,1	256,00
96 H 300*	96	11A	GG	388,08	386,71	—	86	55	100	—	20	57	18,2	298,00
120 H 300*	120	11A	GG	485,10	483,73	—	86	65	110	—	24	62	26,0	411,00

**Type XH – Teilung Pitch 22,225 mm für Riemenbreite for belt width 200**

18 XH 200*	18	6CF	GG	127,34	124,55	142	64,4	60	85	18	20	50	5,0	165,00
20 XH 200*	20	6CF	GG	141,49	138,69	155	64,4	60	95	18	20	55	6,0	174,00
22 XH 200*	22	6CF	GG	155,64	152,84	170	64,4	60	110	18	20	65	7,2	187,00
24 XH 200*	24	6CF	GG	169,79	166,69	184	64,4	60	125	18	25	70	8,6	210,00
26 XH 200*	26	6CF	GG	183,94	181,14	198	64,4	60	140	18	25	80	10,1	240,00
28 XH 200*	28	6CWF	GG	198,08	195,29	212	64,4	60	120	18	25	70	9,6	286,00
30 XH 200*	30	6CWF	GG	212,23	209,44	227	64,4	60	120	18	25	70	10,4	310,00
32 XH 200*	32	6CWF	GG	226,38	223,59	240	64,4	60	130	18	25	75	11,2	335,00
40 XH 200*	40	6CWF	GG	282,98	280,18	297	64,4	60	140	18	25	80	16,0	459,00
48 XH 200*	48	6A	GG	339,57	336,78	—	65,0	80	150	—	30	85	18,4	529,00
60 XH 200*	60	6A	GG	424,47	421,67	—	65,0	80	150	—	30	85	24,3	628,00
72 XH 200*	72	6A	GG	509,36	506,57	—	65,0	80	150	—	40	85	28,1	878,00
84 XH 200*	84	6A	GG	594,25	591,46	—	65,0	80	160	—	40	90	31,9	1.227,00
96 XH 200*	96	6A	GG	679,15	676,35	—	65,0	80	160	—	40	90	37,0	1.592,00

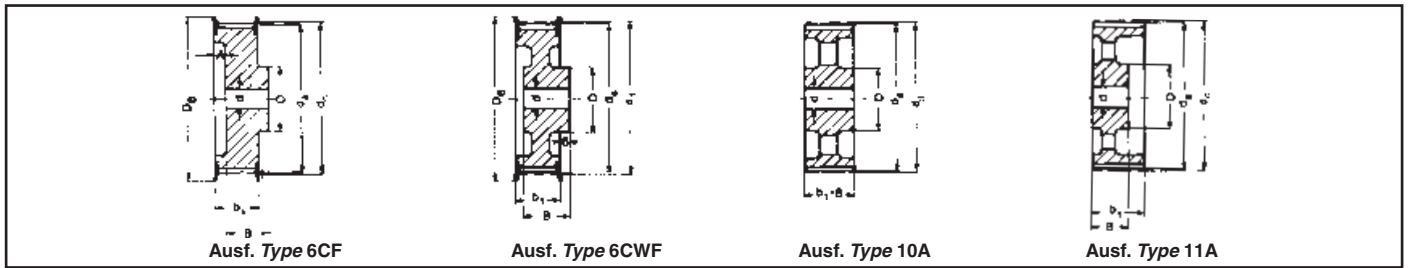

**Type XH – Teilung Pitch 22,225 mm für Riemenbreite for belt width 300**

Bezeichnung Part No.	Anzahl der Zähne No. of teeth	Aus- führung Type	Material	$d_d$ (mm)	$d_a$ (mm)	$D_B$ (mm)	$b_1$ (mm)	B (mm)	D (mm)	A (mm)	Vor- bohrung Pilot bore d (mm)	Fertig- bohrung Finished bore $d_{max}$ (mm)	Gewicht Weight (= kg)	€ Stück each
18 XH 300*	18	6CF	GG	127,34	124,55	142	91,4	70	85	35	20	50	6,8	213,00
20 XH 300*	20	6CF	GG	141,49	138,69	155	91,4	70	95	35	20	55	7,4	225,00
22 XH 300*	22	6CF	GG	155,64	152,84	170	91,4	70	110	35	20	65	9,0	254,00
24 XH 300*	24	6CF	GG	169,79	166,69	184	91,4	70	125	35	25	70	10,6	291,00
26 XH 300*	26	6CF	GG	183,94	181,14	198	91,4	70	140	35	25	80	13,0	330,00
28 XH 300*	28	6CWF	GG	198,08	195,29	212	91,4	70	120	35	25	70	12,0	375,00
30 XH 300*	30	6CWF	GG	212,23	209,44	227	91,4	70	120	35	25	70	13,0	410,00
32 XH 300*	32	6CWF	GG	226,38	223,59	240	91,4	70	130	35	25	75	14,7	447,00
40 XH 300*	40	6CWF	GG	282,98	280,18	297	91,4	70	140	35	25	80	19,9	628,00
48 XH 300*	48	10A	GG	339,57	336,78	—	92,0	92	150	—	30	85	22,5	701,00
60 XH 300*	60	10A	GG	424,47	421,67	—	92,0	92	150	—	30	85	31,5	851,00
72 XH 300*	72	10A	GG	509,36	506,57	—	92,0	92	150	—	40	85	36,4	1.074,00
84 XH 300*	84	10A	GG	594,25	591,46	—	92,0	92	160	—	40	90	43,4	1.462,00
96 XH 300*	96	10A	GG	679,15	676,35	—	92,0	92	160	—	40	90	48,5	2.034,00

**Type XH – Teilung Pitch 22,225 mm für Riemenbreite for belt width 400**

18 XH 400*	18	6CF	GG	127,34	124,55	142	118,4	85	85	47	20	50	8,5	264,00
20 XH 400*	20	6CF	GG	141,49	138,69	155	118,4	85	95	47	20	55	9,4	292,00
22 XH 400*	22	6CF	GG	155,64	152,84	170	118,4	85	110	47	20	65	11,5	321,00
24 XH 400*	24	6CF	GG	169,79	166,69	184	118,4	85	125	47	25	70	13,4	377,00
26 XH 400*	26	6CF	GG	183,94	181,14	198	118,4	85	140	47	25	80	15,6	442,00
28 XH 400*	28	6CWF	GG	198,08	195,29	212	118,4	85	120	47	25	70	14,5	483,00
30 XH 400*	30	6CWF	GG	212,23	209,44	227	118,4	85	120	47	25	70	16,0	510,00
32 XH 400*	32	6CWF	GG	226,38	223,59	240	118,4	85	130	47	25	75	18,0	560,00
40 XH 400*	40	6CWF	GG	282,98	280,18	297	118,4	85	140	47	25	80	24,0	773,00
48 XH 400*	48	11A	GG	339,57	336,78	—	119,0	92	150	—	30	85	30,8	890,00
60 XH 400*	60	11A	GG	424,47	421,67	—	119,0	92	150	—	30	85	36,2	1.034,00
72 XH 400*	72	11A	GG	509,36	506,57	—	119,0	92	150	—	40	85	42,7	1.343,00
84 XH 400*	84	11A	GG	594,25	591,46	—	119,0	92	160	—	40	90	49,7	1.814,00
96 XH 400*	96	11A	GG	679,15	676,35	—	119,0	92	160	—	40	90	59,9	2.615,00

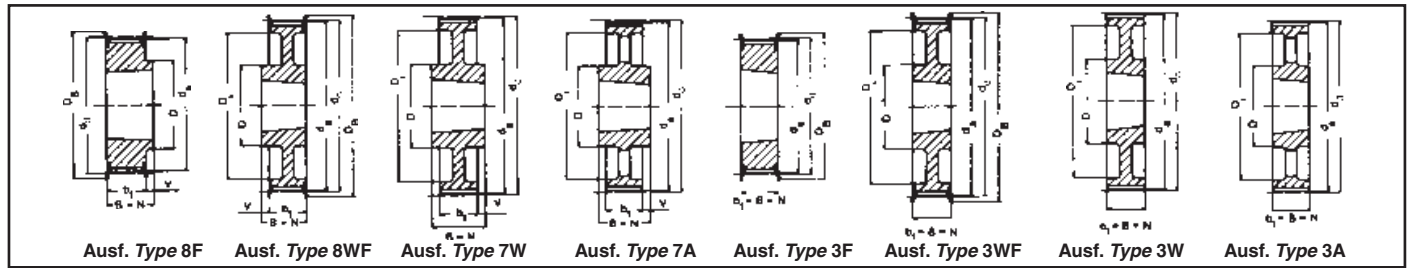

**Type L – Teilung Pitch 9,525 mm für Riemenbreite for belt width 050**

Bezeichnung Part No.	Anzahl der Zähne No. of teeth	Aus- führung Type	Mate- rial	d <sub>d</sub> (mm)	d <sub>a</sub> (mm)	D <sub>B</sub> (mm)	b <sub>1</sub> (mm)	B (mm)	N (mm)	V (mm)	Z (mm)	D (mm)	D <sub>i</sub> (mm)	Taper- Buchse Taper bush	Gewicht ohne Buchse Weight without bush (= kg)	€ Stück ohne Buchse each without bush
TB 18 L 050	18	8F	St	54,57	53,81	60	19,0	22,0	22,0	3,0	—	44	—	1108	0,2	23,10
TB 19 L 050	19	8F	St	57,61	56,84	60	19,0	22,0	22,0	3,0	—	44	—	1108	0,2	23,90
TB 20 L 050	20	8F	St	60,64	59,88	66	19,0	22,0	22,0	3,0	—	48	—	1108	0,2	24,30
TB 21 L 050	21	8F	St	63,67	62,91	71	19,0	22,0	22,0	3,0	—	48	—	1108	0,3	25,40
TB 22 L 050	22	8F	St	66,70	65,94	75	19,0	22,0	22,0	3,0	—	51	—	1108	0,3	26,10
TB 23 L 050	23	8F	GG	69,73	68,97	79	19,0	22,0	22,0	3,0	—	54	—	1108	0,4	26,90
TB 24 L 050	24	8F	GG	72,77	72,00	79	19,0	22,0	22,0	3,0	—	54	—	1108	0,4	27,50
TB 25 L 050	25	8F	GG	75,80	75,04	83	19,0	22,0	22,0	3,0	—	56	—	1108	0,5	28,20
TB 26 L 050	26	8F	GG	78,83	78,07	87	19,0	22,0	22,0	3,0	—	60	—	1108	0,5	29,00
TB 27 L 050	27	8F	GG	81,86	81,10	87	19,0	22,0	22,0	3,0	—	65	—	1108	0,6	29,70
TB 28 L 050	28	8F	GG	84,89	84,13	91	19,0	22,0	22,0	3,0	—	65	—	1108	0,6	30,50
TB 30 L 050	30	8F	GG	90,96	90,20	97	19,0	22,0	22,0	3,0	—	70	—	1108	0,8	32,60
TB 32 L 050	32	8F	GG	97,02	96,26	103	19,0	22,0	22,0	3,0	—	74	—	1108	0,9	35,10
TB 36 L 050	36	8F	GG	109,15	108,39	115	19,0	22,0	22,0	3,0	—	87	—	1108	1,2	37,70
TB 40 L 050	40	8F	GG	121,28	120,51	127	19,0	25,0	25,0	6,0	—	97	—	1610	1,5	44,30
TB 48 L 050	48	8WF	GG	145,53	144,77	152	19,0	25,0	25,0	6,0	—	88	124	1610	2,3	56,20
TB 60 L 050	60	7W	GG	181,91	181,15	—	19,0	25,0	25,0	3,0	—	92	166	1610	2,0	65,20
TB 72 L 050	72	7A	GG	218,30	217,53	—	19,0	25,0	25,0	3,0	—	92	202	1610	3,0	76,40
TB 84 L 050	84	7A	GG	254,68	253,90	—	19,0	25,0	25,0	3,0	—	92	236	1610	4,0	89,80
TB 96 L 050	96	7A	GG	291,06	290,30	—	19,0	32,0	32,0	6,5	—	106	270	2012	5,5	115,00
TB 120 L 050	120	7A	GG	363,83	363,07	—	19,0	32,0	32,0	6,5	—	106	343	2012	6,8	148,00

**Type L – Teilung Pitch 9,525 mm für Riemenbreite for belt width 075**

TB 18 L 075	18	3F	St	54,57	53,81	60	25,0	25,0	25,0	—	—	—	—	1108	0,2	25,70
TB 19 L 075	19	3F	St	57,61	56,84	60	25,0	25,0	25,0	—	—	—	—	1108	0,3	26,90
TB 20 L 075	20	3F	St	60,64	59,88	66	25,0	25,0	25,0	—	—	—	—	1108	0,3	27,20
TB 21 L 075	21	3F	St	63,67	62,91	71	25,0	25,0	25,0	—	—	—	—	1108	0,4	28,20
TB 22 L 075	22	3F	St	66,70	65,94	75	25,0	25,0	25,0	—	—	—	—	1108	0,4	29,00
TB 23 L 075	23	3F	GG	69,73	68,97	79	25,0	25,0	25,0	—	—	—	—	1108	0,4	30,00
TB 24 L 075	24	3F	GG	72,77	72,00	79	25,0	25,0	25,0	—	—	—	—	1108	0,5	31,20
TB 25 L 075	25	3F	GG	75,80	75,04	83	25,0	25,0	25,0	—	—	—	—	1108	0,6	31,90
TB 26 L 075	26	3F	GG	78,83	78,07	87	25,0	25,0	25,0	—	—	—	—	1108	0,6	32,60
TB 27 L 075	27	3F	GG	81,86	81,10	87	25,0	25,0	25,0	—	—	—	—	1108	0,7	34,80
TB 28 L 075	28	3F	GG	84,89	84,13	91	25,0	25,0	25,0	—	—	—	—	1108	0,7	36,20
TB 30 L 075	30	3F	GG	90,96	90,20	97	25,0	25,0	25,0	—	—	—	—	1108	0,9	37,40
TB 32 L 075	32	3F	GG	97,02	96,26	103	25,0	25,0	25,0	—	—	—	—	1108	1,0	40,20
TB 36 L 075	36	3F	GG	109,15	108,39	115	25,0	25,0	25,0	—	—	—	—	1610	1,2	44,60
TB 40 L 075	40	3F	GG	121,28	120,51	127	25,0	25,0	25,0	—	—	—	—	1610	1,7	49,30
TB 48 L 075	48	3WF	GG	145,53	144,77	152	25,0	25,0	25,0	—	—	92	124	1610	2,5	58,40
TB 60 L 075	60	3W	GG	181,91	181,15	—	25,0	25,0	25,0	—	—	92	166	1610	3,0	69,20
TB 72 L 075	72	3A	GG	218,30	217,53	—	25,0	25,0	25,0	—	—	92	202	1610	4,0	85,90
TB 84 L 075	84	7A	GG	254,68	253,90	—	25,0	32,0	32,0	3,5	—	106	236	2012	5,2	104,00
TB 96 L 075	96	7A	GG	291,06	290,30	—	25,0	32,0	32,0	3,5	—	106	270	2012	6,5	129,00
TB 120 L 075	120	7A	GG	363,83	363,07	—	25,0	32,0	32,0	3,5	—	106	343	2012	7,6	160,00

Taper-Buchse Taper bush	1108	1610	2012
Bohrung d <sub>2</sub> (mm) von ... bis ... Bore d <sub>2</sub> (mm) from ... to ...	10-28	14-42	14-50
€/Stück each	7,90	12,40	15,20

St = Stahl Steel  
GG = Grauguss Cast iron  
Fertigungstechnische Änderungen vorbehalten.  
We reserve the right to make technical chan-  
Bohrungsdurchmesser d<sub>2</sub> siehe Seite 3.  
Bore diameters d<sub>2</sub> see page 3.

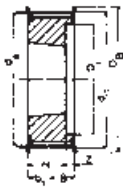

Ausf. Type 5F

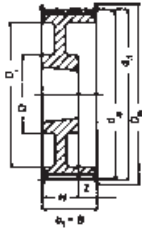

Ausf. Type 5WF

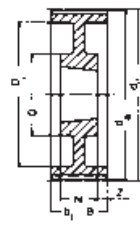

Ausf. Type 9W

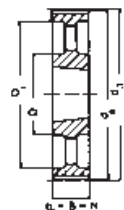

Ausf. Type 3A

**Type L – Teilung Pitch 9,525 mm für Riemenbreite for belt width 100**

Bezeichnung Part No.	Anzahl der Zähne No. of teeth	Aus- führung Type	Mate- rial	d <sub>d</sub> (mm)	d <sub>a</sub> (mm)	D <sub>B</sub> (mm)	b <sub>1</sub> (mm)	B (mm)	N (mm)	V (mm)	Z (mm)	D (mm)	D <sub>i</sub> (mm)	Taper- Buchse Taper bush	Gewicht ohne Buchse Weight without bush (= kg)	€ Stück ohne Buchse each without bush
TB 18 L 100	18	5F	St	54,57	53,81	60	31,0	31,0	22,0	—	9,0	—	38	1108	0,2	27,90
TB 19 L 100	19	5F	St	57,61	56,84	60	31,0	31,0	22,0	—	9,0	—	38	1108	0,3	29,00
TB 20 L 100	20	5F	St	60,64	59,88	66	31,0	31,0	22,0	—	9,0	—	45	1108	0,4	29,70
TB 21 L 100	21	5F	St	63,67	62,91	71	31,0	31,0	22,0	—	9,0	—	47	1108	0,4	30,80
TB 22 L 100	22	5F	St	66,70	65,94	75	31,0	31,0	22,0	—	9,0	—	51	1108	0,4	31,50
TB 23 L 100	23	5F	GG	69,73	68,97	79	32,0	32,0	22,0	—	10,0	—	54	1108	0,5	33,70
TB 24 L 100	24	5F	GG	72,77	72,00	79	32,0	32,0	22,0	—	10,0	—	54	1108	0,6	35,10
TB 25 L 100	25	5F	GG	75,80	75,04	83	32,0	32,0	22,0	—	10,0	—	56	1108	0,6	36,60
TB 26 L 100	26	5F	GG	78,83	78,07	87	32,0	32,0	22,0	—	10,0	—	60	1108	0,7	37,40
TB 27 L 100	27	5F	GG	81,86	81,10	87	32,0	32,0	22,0	—	10,0	—	62	1108	0,8	38,40
TB 28 L 100	28	5F	GG	84,89	84,13	91	32,0	32,0	22,0	—	10,0	—	65	1108	0,8	39,80
TB 30 L 100	30	5F	GG	90,96	90,20	97	32,0	32,0	25,0	—	7,0	—	71	1210	0,9	41,00
TB 32 L 100	32	5F	GG	97,02	96,26	103	32,0	32,0	25,0	—	7,0	—	75	1210	1,0	44,90
TB 36 L 100	36	5F	GG	109,15	108,39	115	32,0	32,0	25,0	—	7,0	—	89	1610	1,4	48,50
TB 40 L 100	40	5F	GG	121,28	120,51	127	32,0	32,0	25,0	—	7,0	—	101	1610	1,7	52,60
TB 48 L 100	48	5WF	GG	145,53	144,77	152	32,0	32,0	25,0	—	7,0	92	124	1610	2,7	64,50
TB 60 L 100	60	9W	GG	181,91	181,15	—	32,0	32,0	25,0	—	3,5	92	166	1610	2,4	76,40
TB 72 L 100	72	3A	GG	218,30	217,53	—	32,0	32,0	32,0	—	—	106	202	2012	4,4	95,60
TB 84 L 100	84	3A	GG	254,68	253,90	—	32,0	32,0	32,0	—	—	106	236	2012	6,0	112,00
TB 96 L 100	96	3A	GG	291,06	290,30	—	32,0	32,0	32,0	—	—	106	270	2012	7,1	137,00
TB 120 L 100	120	3A	GG	363,83	363,07	—	32,0	32,0	32,0	—	—	106	343	2012	8,5	174,00

Taper-Buchse Taper bush	1108	1210	1610	2012
Bohrung d <sub>2</sub> (mm) von ... bis ... Bore d <sub>2</sub> (mm) from ... to ...	10-28	11-32	14-42	14-50
€/Stück each	7,90	10,40	12,40	15,20

St = Stahl Steel  
GG = Grauguss Cast iron  
Fertigungstechnische Änderungen vorbehalten.  
We reserve the right to make technical changes.  
Bohrungsdurchmesser d<sub>2</sub> siehe Seite 3.  
Bore diameters d<sub>2</sub> see page 3.

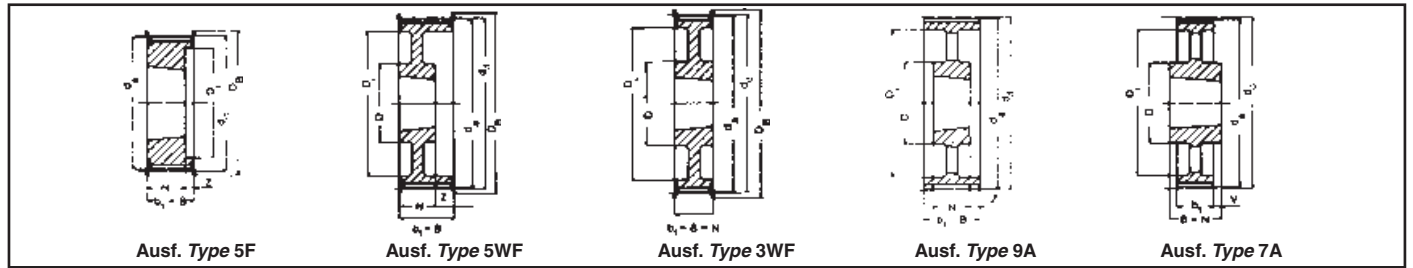

**Type H – Teilung Pitch 12,7 mm für Riemenbreite for belt width 100**

Bezeichnung Part No.	Anzahl der Zähne No. of teeth	Aus- führung Type	Mate- rial	d <sub>d</sub> (mm)	d <sub>a</sub> (mm)	D <sub>B</sub> (mm)	b <sub>1</sub> (mm)	B (mm)	N (mm)	V (mm)	Z (mm)	D (mm)	D <sub>i</sub> (mm)	Taper- Buchse Taper bush	Gewicht ohne Buchse Weight without bush (= kg)	€ Stück ohne Buchse each without bush
TB 16 H 100	16	5F	St	64,68	63,31	71	31,0	31,0	22,0	—	9,0	—	45	1108	0,4	27,90
TB 18 H 100	18	5F	St	72,77	71,39	79	31,0	31,0	25,0	—	6,0	—	52	1210	0,5	32,30
TB 19 H 100	19	5F	St	76,81	75,44	83	31,0	31,0	25,0	—	6,0	—	56	1210	0,6	34,10
TB 20 H 100	20	5F	St	80,55	79,48	87	31,0	31,0	25,0	—	6,0	—	60	1210	0,7	35,60
TB 21 H 100	21	5F	GG	84,89	83,52	91	32,0	32,0	25,0	—	7,0	—	63	1210	0,8	37,40
TB 22 H 100	22	5F	GG	88,94	87,56	93	32,0	32,0	25,0	—	7,0	—	67	1210	0,9	39,20
TB 23 H 100	23	5F	GG	92,98	91,61	97	32,0	32,0	25,0	—	7,0	—	71	1610	0,9	40,60
TB 24 H 100	24	5F	GG	97,02	95,65	103	32,0	32,0	25,0	—	7,0	—	75	1610	1,0	42,00
TB 25 H 100	25	5F	GG	101,06	99,69	106	32,0	32,0	25,0	—	7,0	—	79	1610	1,0	44,30
TB 26 H 100	26	5F	GG	105,11	103,73	111	32,0	32,0	25,0	—	7,0	—	83	1610	1,2	45,70
TB 27 H 100	27	5F	GG	109,15	107,78	115	32,0	32,0	25,0	—	7,0	—	87	1610	1,3	47,50
TB 28 H 100	28	5F	GG	113,19	111,82	119	32,0	32,0	25,0	—	7,0	—	91	1610	1,5	49,30
TB 30 H 100	30	5F	GG	121,28	119,90	127	32,0	32,0	25,0	—	7,0	—	99	1610	1,7	52,60
TB 32 H 100	32	5WF	GG	129,36	127,99	135	32,0	32,0	25,0	—	7,0	92	108	1610	2,0	57,60
TB 36 H 100	36	5WF	GG	145,53	144,16	152	32,0	32,0	25,0	—	7,0	92	124	1610	2,7	65,20
TB 40 H 100	40	5WF	GG	161,70	160,33	168	32,0	32,0	25,0	—	7,0	92	140	1610	3,6	72,80
TB 44 H 100	44	3WF	GG	177,87	176,50	184	32,0	32,0	32,0	—	—	106	153	2012	3,8	81,50
TB 48 H 100	48	3WF	GG	194,04	192,67	200	32,0	32,0	32,0	—	—	106	169	2012	3,2	93,40
TB 60 H 100	60	9A	GG	242,55	241,18	—	34,0	34,0	32,0	—	1,0	106	223	2012	4,8	110,00
TB 72 H 100	72	9A	GG	291,06	289,69	—	34,0	34,0	32,0	—	1,0	106	270	2012	5,7	129,00
TB 84 H 100*	84	9A	GG	339,57	338,20	—	34,0	34,0	32,0	—	1,0	106	318	2012	6,8	153,00
TB 96 H 100*	96	7A	GG	388,08	386,71	—	34,0	45,0	45,0	5,5	—	119	366	2517	8,2	187,00
TB 120 H 100*	120	7A	GG	485,10	483,73	—	34,0	45,0	45,0	5,5	—	119	462	2517	12,1	253,00

**Type H – Teilung Pitch 12,7 mm für Riemenbreite for belt width 150**

TB 18 H 150	18	5F	St	72,77	71,39	79	45,0	45,0	25,0	—	20,0	—	53	1210	0,6	39,20
TB 19 H 150	19	5F	St	76,81	75,44	83	45,0	45,0	25,0	—	20,0	—	56	1210	0,7	40,60
TB 20 H 150	20	5F	St	80,55	79,48	87	45,0	45,0	25,0	—	20,0	—	60	1210	0,8	42,00
TB 21 H 150	21	5F	GG	84,89	83,52	91	45,0	45,0	25,0	—	20,0	—	64	1210	1,0	43,50
TB 22 H 150	22	5F	GG	88,94	87,56	93	45,0	45,0	25,0	—	20,0	—	68	1210	1,2	44,90
TB 23 H 150	23	5F	GG	92,98	91,61	97	45,0	45,0	25,0	—	20,0	—	71	1610	1,3	46,00
TB 24 H 150	24	5F	GG	97,02	95,65	103	45,0	45,0	25,0	—	20,0	—	74	1610	1,2	47,10
TB 25 H 150	25	5F	GG	101,06	99,69	106	45,0	45,0	25,0	—	20,0	—	78	1610	1,2	50,00
TB 26 H 150	26	5F	GG	105,11	103,73	111	45,0	45,0	25,0	—	20,0	—	82	1610	1,4	52,90
TB 27 H 150	27	5F	GG	109,15	107,78	115	45,0	45,0	25,0	—	20,0	—	87	1610	1,6	55,40
TB 28 H 150	28	5F	GG	113,19	111,82	119	45,0	45,0	25,0	—	20,0	—	91	1610	1,8	57,60
TB 30 H 150	30	5F	GG	121,28	119,90	127	45,0	45,0	25,0	—	20,0	—	99	1610	2,0	62,60
TB 32 H 150	32	5WF	GG	129,36	127,99	135	45,0	45,0	25,0	—	20,0	92	108	1610	2,3	68,80
TB 36 H 150	36	5WF	GG	145,53	144,16	152	45,0	45,0	25,0	—	20,0	92	124	1610	3,1	80,50
TB 40 H 150	40	5WF	GG	161,70	160,33	168	45,0	45,0	25,0	—	20,0	92	140	1610	4,0	88,00
TB 44 H 150	44	5WF	GG	177,87	176,50	184	45,0	45,0	32,0	—	13,0	106	153	2012	4,4	102,00
TB 48 H 150	48	5WF	GG	194,04	192,67	200	45,0	45,0	32,0	—	13,0	106	169	2012	4,8	113,00
TB 60 H 150	60	9A	GG	242,55	241,18	—	46,0	46,0	32,0	—	7,0	106	223	2012	5,4	122,00
TB 72 H 150	72	9A	GG	291,06	289,69	—	46,0	46,0	32,0	—	7,0	106	270	2012	6,5	140,00
TB 84 H 150*	84	9A	GG	339,57	338,20	—	46,0	46,0	32,0	—	7,0	106	320	2012	8,4	165,00
TB 96 H 150*	96	9A	GG	388,08	386,71	—	46,0	46,0	45,0	—	0,5	119	366	2517	11,0	217,00
TB 120 H 150*	120	9A	GG	485,10	483,73	—	46,0	46,0	45,0	—	0,5	119	462	2517	14,8	271,00

Taper-Buchse Taper bush	1108	1210	1610	2012	2517
Bohrung d <sub>2</sub> (mm) von ... bis ... Bore d <sub>2</sub> (mm) from ... to ...	10-28	11-32	14-42	14-50	16-60
€/Stück each	7,90	10,40	12,40	15,20	19,10

St = Stahl Steel – GG = Grauguss Cast iron  
Fertigungstechnische Änderungen vorbehalten.  
We reserve the right to make technical changes.  
\* Keine Lagerware Non stock items  
Bohrungsdurchmesser d<sub>2</sub> siehe Seite 3.  
Bore diameters d<sub>2</sub> see page 3.

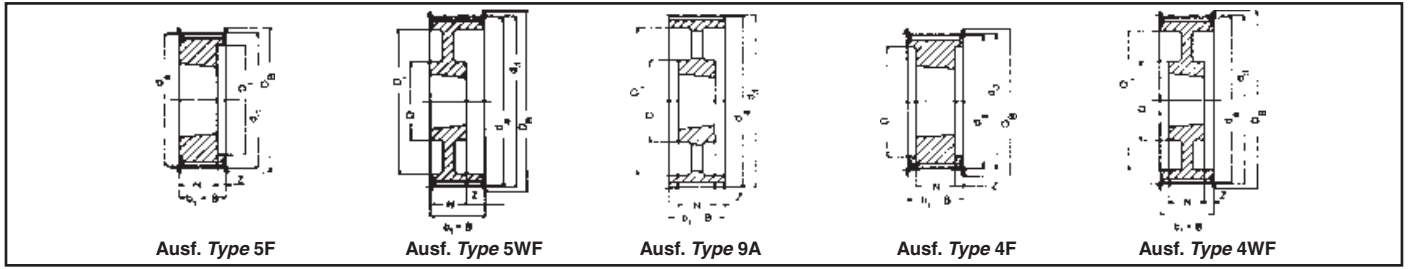

**Type H – Teilung Pitch 12,7 mm für Riemenbreite for belt width 200**

Bezeichnung Part No.	Anzahl der Zähne No. of teeth	Aus- führung Type	Mate- rial	d <sub>d</sub> (mm)	d <sub>a</sub> (mm)	D <sub>B</sub> (mm)	b <sub>1</sub> (mm)	B (mm)	N (mm)	V (mm)	Z (mm)	D (mm)	D <sub>i</sub> (mm)	Taper- Buchse Taper bush	Gewicht ohne Buchse Weight without bush (= kg)	€ Stück ohne Buchse each without bush
TB 18 H 200	18	5F	St	72,77	71,39	79	58,0	58,0	25,0	—	33,0	—	52	1210	0,8	43,10
TB 19 H 200	19	5F	St	76,81	75,44	83	58,0	58,0	25,0	—	33,0	—	56	1610	0,9	45,70
TB 20 H 200	20	5F	St	80,55	79,48	87	58,0	58,0	25,0	—	33,0	—	60	1610	1,0	48,50
TB 21 H 200	21	5F	GG	84,89	83,52	91	58,0	58,0	25,0	—	33,0	—	64	1610	1,7	50,30
TB 22 H 200	22	5F	GG	88,94	87,56	93	58,0	58,0	25,0	—	33,0	—	68	1610	1,5	52,60
TB 23 H 200	23	5F	GG	92,98	91,61	97	58,0	58,0	25,0	—	33,0	—	71	1610	1,8	54,40
TB 24 H 200	24	5F	GG	97,02	95,65	103	58,0	58,0	25,0	—	33,0	—	74	1610	1,5	56,20
TB 25 H 200	25	5F	GG	101,06	99,69	106	58,0	58,0	25,0	—	33,0	—	78	1610	1,5	58,70
TB 26 H 200	26	5F	GG	105,11	103,73	111	58,0	58,0	25,0	—	33,0	—	82	1610	1,8	62,00
TB 27 H 200	27	5F	GG	109,15	107,78	115	58,0	58,0	25,0	—	33,0	—	87	1610	1,9	64,90
TB 28 H 200	28	5F	GG	113,19	111,82	119	58,0	58,0	25,0	—	33,0	—	91	1610	1,9	68,20
TB 30 H 200	30	5F	GG	121,28	119,90	127	58,0	58,0	25,0	—	33,0	—	99	1610	2,3	74,60
TB 32 H 200	32	5F	GG	129,36	127,99	135	58,0	58,0	32,0	—	26,0	—	107	2012	3,0	82,30
TB 36 H 200	36	5WF	GG	145,53	144,16	152	58,0	58,0	32,0	—	26,0	102	124	2012	3,0	96,70
TB 40 H 200	40	5WF	GG	161,70	160,33	168	58,0	58,0	32,0	—	26,0	106	140	2012	3,6	110,00
TB 44 H 200	44	5WF	GG	177,87	176,50	184	58,0	58,0	32,0	—	26,0	106	153	2012	4,5	117,00
TB 48 H 200	48	5WF	GG	194,04	192,67	200	58,0	58,0	45,0	—	13,0	119	169	2517	4,6	134,00
TB 60 H 200	60	9A	GG	242,55	241,18	—	60,0	60,0	45,0	—	7,5	119	223	2517	7,0	150,00
TB 72 H 200	72	9A	GG	291,06	289,69	—	60,0	60,0	45,0	—	7,5	119	270	2517	8,0	168,00
TB 84 H 200*	84	9A	GG	339,57	338,20	—	60,0	60,0	45,0	—	7,5	119	320	2517	9,0	191,00
TB 96 H 200*	96	9A	GG	388,08	386,71	—	60,0	60,0	45,0	—	7,5	119	366	2517	11,5	238,00
TB 120 H 200*	120	9A	GG	485,10	483,73	—	60,0	60,0	45,0	—	7,5	119	462	2517	15,4	323,00

**Type H – Teilung Pitch 12,7 mm für Riemenbreite for belt width 300**

TB 20 H 300	20	4F	St	80,55	79,48	87	84,0	84,0	38,0	—	23,0	—	65	1615	1,5	65,20
TB 21 H 300	21	4F	GG	84,89	83,52	91	84,0	84,0	38,0	—	23,0	—	66	1615	1,2	66,70
TB 22 H 300	22	4F	GG	88,94	87,56	93	84,0	84,0	38,0	—	23,0	—	67	1615	1,6	68,20
TB 23 H 300	23	4F	GG	92,98	91,61	97	84,0	84,0	38,0	—	23,0	—	71	1615	1,8	69,50
TB 24 H 300	24	4F	GG	97,02	95,65	103	84,0	84,0	38,0	—	23,0	—	75	1615	2,1	71,30
TB 25 H 300	25	4F	GG	101,06	99,69	106	84,0	84,0	38,0	—	23,0	—	79	1615	2,0	75,40
TB 26 H 300	26	4F	GG	105,11	103,73	111	84,0	84,0	38,0	—	23,0	—	83	1615	2,7	79,30
TB 27 H 300	27	4F	GG	109,15	107,78	115	84,0	84,0	32,0	—	26,0	—	87	2012	3,0	83,80
TB 28 H 300	28	4F	GG	113,19	111,82	119	84,0	84,0	32,0	—	26,0	—	91	2012	2,4	87,70
TB 30 H 300	30	4F	GG	121,28	119,90	127	84,0	84,0	32,0	—	26,0	—	99	2012	2,9	94,90
TB 32 H 300	32	4F	GG	129,36	127,99	135	84,0	84,0	45,0	—	19,5	—	107	2517	3,3	106,00
TB 36 H 300	36	4F	GG	145,53	144,16	152	84,0	84,0	45,0	—	19,5	—	124	2517	4,5	122,00
TB 40 H 300	40	4F	GG	161,70	160,33	168	84,0	84,0	45,0	—	19,5	—	137	2517	6,0	134,00
TB 44 H 300	44	4WF	GG	177,87	176,50	184	86,0	86,0	45,0	—	20,5	119	153	2517	6,6	155,00
TB 48 H 300	48	4WF	GG	194,04	192,67	200	86,0	86,0	45,0	—	20,5	119	169	2517	7,6	168,00
TB 60 H 300	60	9A	GG	242,55	241,18	—	86,0	86,0	45,0	—	20,5	119	223	2517	8,4	198,00
TB 72 H 300	72	9A	GG	291,06	289,69	—	86,0	86,0	45,0	—	20,5	119	270	2517	10,4	226,00
TB 84 H 300*	84	9A	GG	339,57	338,20	—	86,0	86,0	45,0	—	20,5	119	320	2517	12,5	271,00
TB 96 H 300*	96	9A	GG	388,08	386,71	—	86,0	86,0	76,0	—	5,0	150	362	3030	14,2	383,00
TB 120 H 300*	120	9A	GG	485,10	483,73	—	86,0	86,0	76,0	—	5,0	150	460	3030	18,8	485,00

Taper-Buchse Taper bush	1210	1610	1615	2012	2517	3030
Bohrung d <sub>2</sub> (mm) von ... bis ... Bore d <sub>2</sub> (mm) from ... to ...	11-32	14-42	14-42	14-50	16-60	35-75
€/Stück each	10,40	12,40	13,00	15,20	19,10	32,50

St = Stahl Steel – GG = Grauguss Cast iron  
Fertigungstechnische Änderungen vorbehalten.  
We reserve the right to make technical changes.  
\* Keine Lagerware Non stock items  
Bohrungsdurchmesser d<sub>2</sub> siehe Seite 3.  
Bore diameters d<sub>2</sub> see page 3.

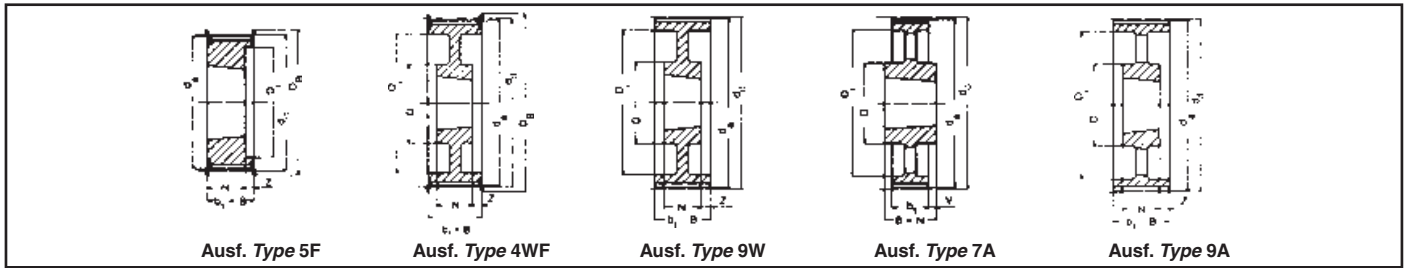

**Type XH – Teilung Pitch 22,225 mm für Riemenbreite for belt width 200**

Bezeichnung Part No.	Anzahl der Zähne No. of teeth	Aus- führung Type	Mate- rial	d <sub>d</sub> (mm)	d <sub>a</sub> (mm)	D <sub>B</sub> (mm)	b <sub>1</sub> (mm)	B (mm)	N (mm)	V (mm)	Z (mm)	D (mm)	D <sub>i</sub> (mm)	Taper- Buchse Taper bush	Gewicht ohne Buchse Weight without bush (= kg)	€ Stück ohne Buchse each without bush
TB 18 XH 200*	18	5F	GG	127,34	124,55	138	64	64	45	—	20,0	—	95	2517	2,6	375,00
TB 20 XH 200*	20	5F	GG	141,49	138,69	154	64	64	45	—	20,0	—	110	2517	3,6	406,00
TB 22 XH 200*	22	5F	GG	155,64	152,84	168	64	64	45	—	20,0	—	120	2517	4,8	432,00
TB 24 XH 200*	24	5F	GG	169,79	166,69	183	64	64	45	—	20,0	—	135	2517	6,1	489,00
TB 26 XH 200*	26	5F	GG	183,94	181,14	198	64	64	45	—	20,0	—	150	2517	7,4	521,00
TB 28 XH 200*	28	4WF	GG	198,08	195,29	211	64	64	45	—	10,0	120	165	2517	9,0	565,00
TB 30 XH 200*	30	4WF	GG	212,23	209,44	226	64	64	45	—	10,0	120	180	2517	8,6	625,00
TB 32 XH 200*	32	4WF	GG	226,38	223,59	240	64	64	45	—	10,0	120	195	2517	9,8	658,00
TB 40 XH 200*	40	4WF	GG	282,98	280,18	296	64	64	51	—	6,5	160	245	3020	13,3	902,00
TB 48 XH 200*	48	9W	GG	339,57	336,78	—	64	64	51	—	6,5	160	300	3020	19,0	1.222,00

**Type XH – Teilung Pitch 22,225 mm für Riemenbreite for belt width 300**

TB 18 XH 300*	18	5F	GG	127,34	124,55	138	90	90	45	—	45,0	—	95	2517	3,7	482,00
TB 20 XH 300*	20	5F	GG	141,49	138,69	154	90	90	45	—	45,0	—	110	2517	4,7	544,00
TB 22 XH 300*	22	5F	GG	155,64	152,84	168	90	90	45	—	45,0	—	120	2517	6,0	569,00
TB 24 XH 300*	24	5F	GG	169,79	166,69	183	90	90	45	—	45,0	—	135	2517	7,6	638,00
TB 26 XH 300*	26	5F	GG	183,94	181,14	198	90	90	45	—	45,0	—	150	2517	9,8	685,00
TB 28 XH 300*	28	5F	GG	198,08	195,29	211	90	90	51	—	39,0	—	165	3020	11,6	764,00
TB 30 XH 300*	30	5F	GG	212,23	209,44	226	90	90	51	—	39,0	—	180	3020	11,9	840,00
TB 32 XH 300*	32	5F	GG	226,38	223,59	240	90	90	51	—	39,0	—	195	3020	13,8	874,00
TB 40 XH 300*	40	4WF	GG	282,98	280,18	296	90	90	51	—	19,5	160	245	3020	19,5	1.144,00
TB 48 XH 300*	48	9W	GG	339,57	336,78	—	90	90	51	—	19,5	160	300	3020	27,0	1.329,00

Taper-Buchse Taper bush	2517	3020	3535	4040
Bohrung d <sub>2</sub> (mm) von ... bis ... Bore d <sub>2</sub> (mm) from ... to ...	16-60	25-75	35-90	40-100
€/Stück each	19,10	24,80	62,60	88,00

GG = Grauguss Cast iron  
Fertigungstechnische Änderungen vorbehalten.  
We reserve the right to make technical changes.  
\* Keine Lagerware Non stock items  
Bohrungsdurchmesser d<sub>2</sub> siehe Seite 3.  
Bore diameters d<sub>2</sub> see page 3.



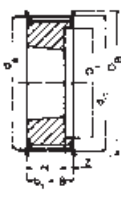

Ausf. Type 5F

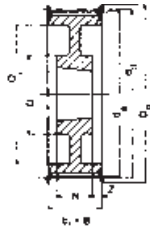

Ausf. Type 4WF

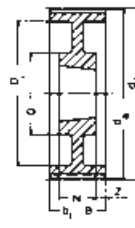

Ausf. Type 9W

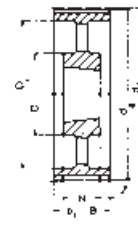

Ausf. Type 9A

**Type XH – Teilung Pitch 22,225 mm für Riemenbreite for belt width 400**

Bezeichnung Part No.	Anzahl der Zähne No. of teeth	Aus- führung Type	Mate- rial	d <sub>d</sub> (mm)	d <sub>a</sub> (mm)	D <sub>B</sub> (mm)	b <sub>1</sub> (mm)	B (mm)	N (mm)	V (mm)	Z (mm)	D (mm)	D <sub>i</sub> (mm)	Taper- Buchse Taper bush	Gewicht ohne Buchse Weight without bush (= kg)	€ Stück ohne Buchse each without bush
TB 20 XH 400*	20	5F	GG	141,49	138,69	154	119	119	45	—	74,0	—	110	2517	6,0	<b>587,00</b>
TB 22 XH 400*	22	5F	GG	155,64	152,84	168	119	119	45	—	74,0	—	120	2517	7,2	<b>650,00</b>
TB 24 XH 400*	24	5F	GG	169,79	166,69	183	119	119	51	—	68,0	—	135	3020	8,4	<b>694,00</b>
TB 26 XH 400*	26	5F	GG	183,94	181,14	198	119	119	51	—	68,0	—	150	3020	10,3	<b>810,00</b>
TB 28 XH 400*	28	5F	GG	198,08	195,29	211	119	119	51	—	68,0	—	165	3020	12,3	<b>867,00</b>
TB 30 XH 400*	30	5F	GG	212,23	209,44	226	119	119	51	—	68,0	—	180	3020	14,3	<b>922,00</b>
TB 32 XH 400*	32	5F	GG	226,38	223,59	240	119	119	51	—	68,0	—	195	3020	19,9	<b>1.008,00</b>
TB 40 XH 400*	40	4WF	GG	282,98	280,18	296	119	119	89	—	15,0	190	245	3535	24,6	<b>1.076,00</b>
TB 48 XH 400*	48	9W	GG	339,57	336,78	—	119	119	89	—	15,0	190	300	3535	30,0	<b>1.378,00</b>

Taper-Buchse Taper bush	2517	3020	3535	4040
Bohrung d <sub>2</sub> (mm) von ... bis ... Bore d <sub>2</sub> (mm) from ... to ...	16-60	25-75	35-90	40-100
€/Stück each	<b>19,10</b>	<b>24,80</b>	<b>62,60</b>	<b>88,00</b>

GG = Grauguss Cast iron  
Fertigungstechnische Änderungen vorbehalten.  
We reserve the right to make technical changes.  
\* Keine Lagerware Non stock items  
Bohrungsdurchmesser d<sub>2</sub> siehe Seite 3.  
Bore diameters d<sub>2</sub> see page 3.

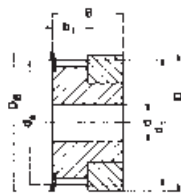

Ausf. Type 1F

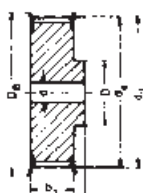

Ausf. Type 6F

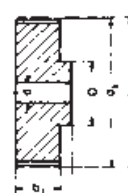

Ausf. Type 6

**Type 3M – Teilung Pitch 3 mm für Riemenbreite for belt width 6 mm**

Keine Lagerware  
Non stock items

Bezeichnung Part No.	Anzahl der Zähne No. of teeth	Aus- führung Type	Material	d <sub>d</sub> (mm)	d <sub>a</sub> (mm)	D <sub>B</sub> (mm)	b <sub>1</sub> (mm)	B (mm)	D (mm)	Vor- bohrung Pilot bore d (mm)	Fertig- bohrung Finished bore d <sub>max</sub> (mm)	Gewicht Weight (= kg)	€ Stück each
10-3M-6	10	1F	Al	9,55	8,79	13,0	7,2	14,5	13,0	—	3		auf Anfrage on request
12-3M-6	12	1F	Al	11,46	10,70	15,0	7,2	14,5	15,0	—	5		
14-3M-6	14	1F	Al	13,37	12,61	16,0	7,2	14,5	16,0	—	6		
15-3M-6	15	1F	Al	14,32	13,56	17,5	7,2	14,5	17,5	—	6		
16-3M-6	16	6F	Al	15,28	14,52	18,0	9,8	17,5	10,0	4	7		
18-3M-6	18	6F	Al	17,19	16,43	19,5	9,8	17,5	11,0	6	8		
20-3M-6	20	6F	Al	19,10	18,34	23,0	9,8	17,5	13,0	6	9		
21-3M-6	21	6F	Al	20,05	19,29	25,0	9,8	17,5	14,0	6	9		
22-3M-6	22	6F	Al	21,01	20,25	25,0	9,8	17,5	14,0	6	9		
24-3M-6	24	6F	Al	22,92	22,16	25,0	9,8	17,5	14,0	6	9		
26-3M-6	26	6F	Al	24,83	24,07	28,0	9,8	17,5	16,0	6	11		
28-3M-6	28	6F	Al	26,74	25,98	32,0	9,8	17,5	18,0	6	12		
30-3M-6	30	6F	Al	28,65	27,89	32,0	9,8	17,5	20,0	6	14		
32-3M-6	32	6F	Al	30,56	29,80	36,0	9,8	17,5	22,0	6	15		
36-3M-6	36	6F	Al	34,38	33,62	38,0	10,3	18,0	26,0	6	16		
40-3M-6	40	6F	Al	38,20	37,44	42,0	10,3	18,0	28,0	6	18		
44-3M-6	44	6F	Al	42,02	41,26	48,0	10,3	18,0	33,0	6	20		
48-3M-6	48	6	Al	45,84	45,08	—	10,3	18,6	33,0	8	20		
60-3M-6	60	6	Al	57,30	56,54	—	10,3	18,6	33,0	8	20		
72-3M-6	72	6	Al	68,75	67,99	—	10,3	18,6	33,0	8	20		

**Type 3M – Teilung Pitch 3 mm für Riemenbreite for belt width 9 mm**

10-3M-9	10	1F	Al	9,55	8,79	13,0	10,2	17,5	13,0	—	3	0,004	<b>9,80</b>
12-3M-9	12	1F	Al	11,46	10,70	15,0	10,2	17,5	15,0	—	5	0,006	<b>10,20</b>
14-3M-9	14	1F	Al	13,37	12,61	16,0	10,2	17,5	16,0	—	6	0,007	<b>10,50</b>
15-3M-9	15	1F	Al	14,32	13,56	17,5	10,2	17,5	17,5	—	6	0,008	<b>10,80</b>
16-3M-9	16	6F	Al	15,28	14,52	18,0	12,8	20,6	10,0	4	7	0,007	<b>11,60</b>
18-3M-9	18	6F	Al	17,19	16,43	19,5	12,8	20,6	11,0	6	8	0,008	<b>13,10</b>
20-3M-9	20	6F	Al	19,10	18,34	23,0	12,8	20,6	13,0	6	9	0,010	<b>13,40</b>
21-3M-9	21	6F	Al	20,05	19,29	25,0	12,8	20,6	14,0	6	9	0,013	<b>13,80</b>
22-3M-9	22	6F	Al	21,01	20,25	25,0	12,8	20,6	14,0	6	9	0,014	<b>14,90</b>
24-3M-9	24	6F	Al	22,92	22,16	25,0	12,8	20,6	14,0	6	9	0,016	<b>15,20</b>
26-3M-9	26	6F	Al	24,83	24,07	28,0	12,8	20,6	16,0	6	11	0,018	<b>16,40</b>
28-3M-9	28	6F	Al	26,74	25,98	32,0	12,8	20,6	18,0	6	12	0,024	<b>17,00</b>
30-3M-9	30	6F	Al	28,65	27,89	32,0	12,8	20,6	20,0	6	14	0,028	<b>17,70</b>
32-3M-9	32	6F	Al	30,56	29,80	36,0	12,8	20,6	22,0	6	15	0,032	<b>18,50</b>
36-3M-9	36	6F	Al	34,38	33,62	38,0	13,4	22,2	26,0	6	16	0,045	<b>20,30</b>
40-3M-9	40	6F	Al	38,20	37,44	42,0	13,4	22,2	28,0	6	18	0,055	<b>20,70</b>
44-3M-9	44	6F	Al	42,02	41,26	48,0	13,4	22,2	33,0	6	20	0,074	<b>25,10</b>
48-3M-9	48	6	Al	45,84	45,08	—	13,4	22,2	33,0	8	20	0,074	<b>26,90</b>
60-3M-9	60	6	Al	57,30	56,54	—	13,4	22,2	33,0	8	20	0,106	<b>32,30</b>
72-3M-9	72	6	Al	68,75	67,99	—	13,4	22,2	33,0	8	20	0,145	<b>40,60</b>

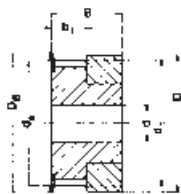

Ausf. Type 1F

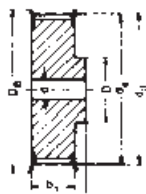

Ausf. Type 6F



Ausf. Type 6

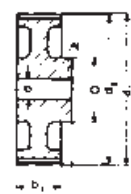

Ausf. Type 6W

**Type 3M – Teilung Pitch 3 mm für Riemenbreite for belt width 15 mm**

Bezeichnung Part No.	Anzahl der Zähne No. of teeth	Aus- führung Type	Material	d <sub>d</sub> (mm)	d <sub>a</sub> (mm)	D <sub>B</sub> (mm)	b <sub>1</sub> (mm)	B (mm)	D (mm)	Vor- bohrung Pilot bore d (mm)	Fertig- bohrung Finished bore d <sub>max</sub> (mm)	Gewicht Weight (= kg)	€ Stück each
10-3M-15	10	1F	Al	9,55	8,79	13,0	17,0	26	13,0	—	3	0,006	10,80
12-3M-15	12	1F	Al	11,46	10,70	15,0	17,0	26	15,0	—	5	0,008	11,30
14-3M-15	14	1F	Al	13,37	12,61	16,0	17,0	26	16,0	—	6	0,010	12,30
15-3M-15	15	1F	Al	14,32	13,56	17,5	17,0	26	17,5	—	6	0,012	12,60
16-3M-15	16	6F	Al	15,28	14,52	18,0	19,5	26	10,0	4	7	0,010	13,40
18-3M-15	18	6F	Al	17,19	16,43	19,5	19,5	26	11,0	6	8	0,012	13,80
20-3M-15	20	6F	Al	19,10	18,34	23,0	19,5	26	13,0	6	9	0,014	14,40
21-3M-15	21	6F	Al	20,05	19,29	25,0	19,5	26	14,0	6	9	0,016	14,90
22-3M-15	22	6F	Al	21,01	20,25	25,0	19,5	26	14,0	6	9	0,018	16,40
24-3M-15	24	6F	Al	22,92	22,16	25,0	19,5	26	14,0	6	9	0,020	17,00
26-3M-15	26	6F	Al	24,83	24,07	28,0	19,5	26	16,0	6	11	0,027	17,70
28-3M-15	28	6F	Al	26,74	25,98	32,0	19,5	26	18,0	6	12	0,030	18,20
30-3M-15	30	6F	Al	28,65	27,89	32,0	19,5	26	20,0	6	14	0,035	19,50
32-3M-15	32	6F	Al	30,56	29,80	36,0	19,5	26	22,0	6	15	0,042	21,00
36-3M-15	36	6F	Al	34,38	33,62	38,0	20,0	30	26,0	6	16	0,060	24,30
40-3M-15	40	6F	Al	38,20	37,44	42,0	20,0	30	28,0	6	18	0,075	24,60
44-3M-15	44	6F	Al	42,02	41,26	48,0	20,0	30	33,0	6	20	0,100	29,00
48-3M-15	48	6	Al	45,84	45,08	—	20,0	30	33,0	8	20	0,103	31,90
60-3M-15	60	6	Al	57,30	56,54	—	20,0	30	33,0	8	20	0,150	39,20
72-3M-15	72	6	Al	68,75	67,99	—	20,0	30	33,0	8	20	0,212	47,10

**Type 5M – Teilung Pitch 5 mm für Riemenbreite for belt width 9 mm**

12-5M-9	12	6F	St	19,10	17,96	23	14,5	20,0	13,0	4	7	0,028	10,50
14-5M-9	14	6F	St	22,28	21,14	25	14,5	20,0	14,0	6	8	0,034	11,30
15-5M-9	15	6F	St	23,87	22,73	28	14,5	20,0	16,0	6	10	0,042	11,60
16-5M-9	16	6F	St	25,46	24,32	28	14,5	20,0	16,5	6	10	0,050	12,30
18-5M-9	18	6F	St	28,65	27,51	32	14,5	20,0	20,0	6	12	0,070	13,40
20-5M-9	20	6F	St	31,83	30,69	36	14,5	22,5	23,0	6	14	0,094	14,40
21-5M-9	21	6F	St	33,42	32,28	38	14,5	22,5	24,0	6	14	0,110	15,20
22-5M-9	22	6F	St	35,01	33,87	38	14,5	22,5	25,5	6	14	0,118	15,90
24-5M-9	24	6F	St	38,20	37,06	42	14,5	22,5	27,0	6	16	0,145	16,70
26-5M-9	26	6F	St	41,38	40,24	44	14,5	22,5	30,0	6	18	0,170	17,40
28-5M-9	28	6F	St	44,56	43,42	48	14,5	22,5	30,5	6	18	0,200	18,20
30-5M-9	30	6F	St	47,75	46,61	51	14,5	22,5	35,0	6	20	0,236	18,90
32-5M-9	32	6F	St	50,93	49,79	54	14,5	22,5	38,0	8	22	0,270	20,30
36-5M-9	36	6F	St	57,30	56,16	60	14,5	22,5	38,0	8	22	0,324	22,10
40-5M-9	40	6F	St	63,66	62,52	71	14,5	22,5	38,0	8	22	0,400	23,10
44-5M-9	44	6W	Al	70,03	68,89	—	14,5	25,5	38,0	8	22	0,170	27,50
48-5M-9	48	6W	Al	76,39	75,25	—	14,5	25,5	45,0	8	25	0,182	29,70
60-5M-9	60	6W	Al	95,49	94,35	—	14,5	25,5	45,0	8	25	0,230	37,40
72-5M-9	72	6W	Al	114,59	113,45	—	14,5	25,5	45,0	8	25	0,270	44,90

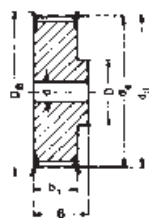

Ausf. Type 6F



Ausf. Type 6W

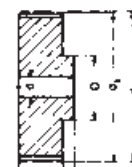

Ausf. Type 6

**Type 5M – Teilung Pitch 5 mm für Riemenbreite for belt width 15 mm**

Bezeichnung Part No.	Anzahl der Zähne No. of teeth	Aus- führung Type	Material	d <sub>d</sub> (mm)	d <sub>a</sub> (mm)	D <sub>B</sub> (mm)	b <sub>1</sub> (mm)	B (mm)	D (mm)	Vor- bohrung Pilot bore d (mm)	Fertig- bohrung Finished bore d <sub>max</sub> (mm)	Gewicht Weight (= kg)	€ Stück each
12-5M-15	12	6F	St	19,10	17,96	25	20,5	26	13,0	4	7	0,034	<b>12,00</b>
14-5M-15	14	6F	St	22,28	21,14	25	20,5	26	14,0	6	8	0,046	<b>12,60</b>
15-5M-15	15	6F	St	23,87	22,73	28	20,5	26	16,0	6	10	0,056	<b>13,40</b>
16-5M-15	16	6F	St	25,46	24,32	28	20,5	26	16,5	6	10	0,064	<b>14,40</b>
18-5M-15	18	6F	St	28,65	27,51	32	20,5	26	20,0	6	12	0,086	<b>15,20</b>
20-5M-15	20	6F	St	31,83	30,69	36	20,5	26	23,0	6	14	0,112	<b>15,90</b>
21-5M-15	21	6F	St	33,42	32,28	38	20,5	26	24,0	6	14	0,130	<b>17,00</b>
22-5M-15	22	6F	St	35,01	33,87	38	20,5	26	25,5	6	14	0,140	<b>17,70</b>
24-5M-15	24	6F	St	38,20	37,06	42	20,5	28	27,0	6	16	0,180	<b>18,90</b>
26-5M-15	26	6F	St	41,38	40,24	44	20,5	28	30,0	6	18	0,220	<b>19,20</b>
28-5M-15	28	6F	St	44,56	43,42	48	20,5	28	30,5	6	18	0,250	<b>20,30</b>
30-5M-15	30	6F	St	47,75	46,61	51	20,5	28	35,0	6	20	0,300	<b>22,10</b>
32-5M-15	32	6F	St	50,93	49,79	54	20,5	28	38,0	8	22	0,350	<b>23,90</b>
36-5M-15	36	6F	St	57,30	56,16	60	20,5	28	38,0	8	22	0,426	<b>25,40</b>
40-5M-15	40	6F	St	63,66	62,52	71	20,5	28	38,0	8	22	0,520	<b>27,20</b>
44-5M-15	44	6W	Al	70,03	68,89	—	20,5	30	38,0	8	22	0,225	<b>31,90</b>
48-5M-15	48	6W	Al	76,39	75,25	—	20,5	30	38,0	8	25	0,187	<b>35,60</b>
60-5M-15	60	6W	Al	95,49	94,35	—	20,5	30	50,0	8	25	0,305	<b>43,80</b>
72-5M-15	72	6W	Al	114,59	113,45	—	20,5	30	50,0	8	25	0,375	<b>52,60</b>

**Type 5M – Teilung Pitch 5 mm für Riemenbreite for belt width 25 mm**

12-5M-25	12	6F	St	19,10	17,96	25	30	36	13,0	4	7	0,050	<b>14,90</b>
14-5M-25	14	6F	St	22,28	21,14	25	30	36	14,0	6	8	0,070	<b>15,90</b>
15-5M-25	15	6F	St	23,87	22,73	28	30	36	16,0	6	10	0,080	<b>16,70</b>
16-5M-25	16	6F	St	25,46	24,32	28	30	36	16,5	6	10	0,100	<b>17,40</b>
18-5M-25	18	6F	St	28,65	27,51	32	30	36	20,0	6	12	0,120	<b>18,20</b>
20-5M-25	20	6F	St	31,83	30,69	36	30	36	23,0	6	14	0,160	<b>18,90</b>
21-5M-25	21	6F	St	33,42	32,28	38	30	38	24,0	6	14	0,190	<b>20,00</b>
22-5M-25	22	6F	St	35,01	33,87	38	30	38	25,5	6	14	0,210	<b>21,00</b>
24-5M-25	24	6F	St	38,20	37,06	42	30	38	27,0	6	16	0,250	<b>22,80</b>
26-5M-25	26	6F	St	41,38	40,24	44	30	38	30,0	6	18	0,300	<b>24,60</b>
28-5M-25	28	6F	St	44,56	43,42	48	30	38	30,5	6	18	0,350	<b>26,10</b>
30-5M-25	30	6F	St	47,75	46,61	51	30	38	35,0	6	20	0,420	<b>28,70</b>
32-5M-25	32	6F	St	50,93	49,79	54	30	38	38,0	8	22	0,480	<b>30,80</b>
36-5M-25	36	6F	St	57,30	56,16	60	30	38	38,0	8	22	0,590	<b>32,60</b>
40-5M-25	40	6F	St	63,66	62,52	71	30	38	38,0	8	22	0,740	<b>37,40</b>
44-5M-25	44	6W	Al	70,03	68,89	—	30	40	38,0	8	22	0,320	<b>44,90</b>
48-5M-25	48	6W	Al	76,39	75,25	—	30	40	38,0	8	25	0,275	<b>48,50</b>
60-5M-25	60	6W	Al	95,49	94,35	—	30	40	50,0	8	25	0,435	<b>60,50</b>
72-5M-25	72	6W	Al	114,59	113,45	—	30	40	50,0	8	25	0,525	<b>72,10</b>

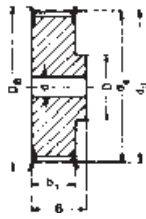

Ausf. Type 6F

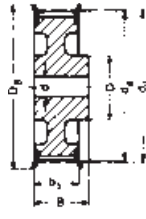

Ausf. Type 6WF

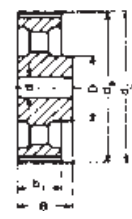

Ausf. Type 6A

**Type 8M – Teilung Pitch 8 mm für Riemenbreite for belt width 20 mm**

Bezeichnung Part No.	Anzahl der Zähne No. of teeth	Aus- führung Type	Material	d <sub>d</sub> (mm)	d <sub>a</sub> (mm)	D <sub>B</sub> (mm)	b <sub>1</sub> (mm)	B (mm)	D (mm)	D <sub>i</sub> (mm)	Vor- bohrung Pilot bore d (mm)	Fertig- bohrung Finished bore d <sub>max</sub> (mm)	Gewicht Weight (= kg)	€ Stück each
22-8M-20	22	6F	St	56,02	54,65	60,0	28	38	43	—	12	30	0,54	24,30
24-8M-20	24	6F	St	61,12	59,75	66,0	28	38	45	—	12	30	0,65	26,10
26-8M-20	26	6F	St	66,21	64,84	71,0	28	38	50	—	12	35	0,80	27,90
28-8M-20	28	6F	St	71,30	70,08	75,0	28	38	50	—	15	35	0,87	29,70
30-8M-20	30	6F	St	76,39	75,13	83,0	28	38	55	—	15	35	1,02	31,50
32-8M-20	32	6F	St	81,49	80,16	87,0	28	38	60	—	15	40	1,20	34,40
34-8M-20	34	6F	St	86,58	85,22	91,0	28	38	70	—	15	45	1,40	36,60
36-8M-20	36	6F	St	91,67	90,30	98,5	28	38	70	—	15	45	1,55	38,40
38-8M-20	38	6F	St	96,77	95,39	103,0	28	38	75	—	15	45	1,65	41,30
40-8M-20	40	6F	GG	101,86	100,49	106,0	28	38	75	—	15	45	1,80	44,90
44-8M-20	44	6F	GG	112,05	110,67	119,0	28	38	75	—	15	45	2,10	52,60
48-8M-20	48	6F	GG	122,23	120,86	127,0	28	38	75	—	15	45	2,44	57,60
56-8M-20	56	6WF	GG	142,60	141,23	148,0	28	38	80	117	15	45	2,60	74,60
64-8M-20	64	6WF	GG	162,97	161,60	168,0	28	38	80	137	15	45	2,90	87,70
72-8M-20	72	6WF	GG	183,35	181,97	192,0	28	38	80	158	15	45	3,10	98,50
80-8M-20	80	6A	GG	203,72	202,35	—	28	38	90	180	15	50	3,80	104,00
90-8M-20	90	6A	GG	229,18	227,81	—	28	38	90	204	15	50	4,20	122,00
112-8M-20	112	6A	GG	285,21	283,83	—	28	38	90	260	18	50	5,20	158,00
144-8M-20	144	6A	GG	366,69	365,32	—	28	38	90	341	20	50	7,50	201,00
168-8M-20	168	6A	GG	427,81	426,44	—	28	38	100	402	20	55	10,00	304,00
192-8M-20	192	6A	GG	488,92	487,55	—	28	38	100	463	20	55	14,40	367,00

**Type 8M – Teilung Pitch 8 mm für Riemenbreite for belt width 30 mm**

22-8M-30	22	6F	St	56,02	54,65	60,0	38	48	43	—	12	30	0,69	27,90
24-8M-30	24	6F	St	61,12	59,75	66,0	38	48	45	—	12	30	0,84	29,70
26-8M-30	26	6F	St	66,21	64,84	71,0	38	48	50	—	12	35	1,00	31,90
28-8M-30	28	6F	St	71,30	70,08	75,0	38	48	50	—	15	35	1,12	34,80
30-8M-30	30	6F	St	76,39	75,13	83,0	38	48	55	—	15	35	1,32	37,70
32-8M-30	32	6F	St	81,49	80,16	87,0	38	48	60	—	15	40	1,50	39,80
34-8M-30	34	6F	St	86,58	85,22	91,0	38	48	70	—	15	45	1,80	42,00
36-8M-30	36	6F	St	91,67	90,30	98,5	38	48	70	—	15	45	1,99	44,90
38-8M-30	38	6F	St	96,77	95,39	103,0	38	48	75	—	15	45	2,27	48,20
40-8M-30	40	6F	GG	101,86	100,49	106,0	38	48	75	—	15	45	2,40	52,60
44-8M-30	44	6F	GG	112,05	110,67	119,0	38	48	75	—	15	45	2,80	60,20
48-8M-30	48	6F	GG	122,23	120,86	127,0	38	48	75	—	15	45	3,20	67,00
56-8M-30	56	6WF	GG	142,60	141,23	148,0	38	48	90	117	15	50	3,60	88,80
64-8M-30	64	6WF	GG	162,97	161,60	168,0	38	48	90	137	15	50	4,30	101,00
72-8M-30	72	6WF	GG	183,35	181,97	192,0	38	48	95	158	15	50	4,80	112,00
80-8M-30	80	6A	GG	203,72	202,35	—	38	48	100	180	15	55	5,10	129,00
90-8M-30	90	6A	GG	229,18	227,81	—	38	48	100	204	15	55	5,70	143,00
112-8M-30	112	6A	GG	285,21	283,83	—	38	48	100	260	18	55	6,80	163,00
144-8M-30	144	6A	GG	366,69	365,32	—	38	48	100	341	20	55	9,30	205,00
168-8M-30	168	6A	GG	427,81	426,44	—	38	48	100	402	20	55	11,40	308,00
192-8M-30	192	6A	GG	488,92	487,55	—	38	48	100	463	20	55	16,00	374,00

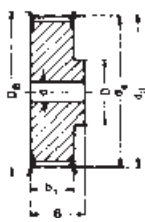

Ausf. Type 6F

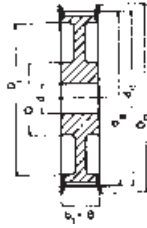

Ausf. Type 10WF



Ausf. Type 10A

**Type 8M – Teilung Pitch 8 mm für Riemenbreite for belt width 50 mm**

Bezeichnung Part No.	Anzahl der Zähne No. of teeth	Aus- führung Type	Material	d <sub>d</sub> (mm)	d <sub>a</sub> (mm)	D <sub>B</sub> (mm)	b <sub>1</sub> (mm)	B (mm)	D (mm)	D <sub>i</sub> (mm)	Vor- bohrung Pilot bore d (mm)	Fertig- bohrung Finished bore d <sub>max</sub> (mm)	Gewicht Weight (= kg)	€ Stück each
22-8M-50	22	6F	St	56,02	54,65	60,0	60	70	43	—	12	30	1,00	36,60
24-8M-50	24	6F	St	61,12	59,75	66,0	60	70	45	—	12	30	1,20	38,00
26-8M-50	26	6F	St	66,21	64,84	71,0	60	70	50	—	12	35	1,50	41,60
28-8M-50	28	6F	St	71,30	70,08	75,0	60	70	50	—	15	35	1,67	46,00
30-8M-50	30	6F	St	76,39	75,13	83,0	60	70	55	—	15	35	1,97	48,20
32-8M-50	32	6F	St	81,49	80,16	87,0	60	70	60	—	15	40	2,27	52,60
34-8M-50	34	6F	St	86,58	85,22	91,0	60	70	70	—	15	45	2,69	55,40
36-8M-50	36	6F	St	91,67	90,30	98,5	60	70	70	—	15	45	2,97	59,40
38-8M-50	38	6F	St	96,77	95,39	103,0	60	70	75	—	15	45	3,23	64,10
40-8M-50	40	6F	GG	101,86	100,49	106,0	60	70	75	—	18	45	3,50	67,00
44-8M-50	44	6F	GG	112,05	110,67	119,0	60	70	75	—	18	45	3,90	78,20
48-8M-50	48	6F	GG	122,23	120,86	127,0	60	70	80	—	18	45	4,30	88,00
56-8M-50	56	10WF	GG	142,60	141,23	148,0	60	60	90	117	18	50	5,00	108,00
64-8M-50	64	10WF	GG	162,97	161,60	168,0	60	60	100	137	18	55	5,60	126,00
72-8M-50	72	10WF	GG	183,35	181,97	192,0	60	60	100	158	18	55	6,80	134,00
80-8M-50	80	10A	GG	203,72	202,35	—	60	60	110	180	18	60	6,90	160,00
90-8M-50	90	10A	GG	229,18	227,81	—	60	60	110	204	18	60	8,60	187,00
112-8M-50	112	10A	GG	285,21	283,83	—	60	60	110	260	18	60	9,60	210,00
144-8M-50	144	10A	GG	366,69	365,32	—	60	60	110	341	20	60	13,80	287,00
168-8M-50	168	10A	GG	427,81	426,44	—	60	60	120	402	20	65	16,00	393,00
192-8M-50	192	10A	GG	488,92	487,55	—	60	60	130	463	20	70	22,40	503,00

**Type 8M – Teilung Pitch 8 mm für Riemenbreite for belt width 85 mm**

22-8M-85	22	6F	St	56,02	54,65	60,0	95	105	43	—	12	30	1,55	46,70
24-8M-85	24	6F	St	61,12	59,75	66,0	95	105	45	—	12	30	1,90	50,70
26-8M-85	26	6F	St	66,21	64,84	71,0	95	105	50	—	12	35	2,25	54,40
28-8M-85	28	6F	St	71,30	70,08	75,0	95	105	50	—	15	35	2,55	62,60
30-8M-85	30	6F	St	76,39	75,13	83,0	95	105	55	—	15	35	3,00	67,00
32-8M-85	32	6F	St	81,49	80,16	87,0	95	105	60	—	15	40	3,57	70,30
34-8M-85	34	6F	St	86,58	85,22	91,0	95	105	70	—	15	45	4,00	76,10
36-8M-85	36	6F	St	91,67	90,30	98,5	95	105	70	—	15	45	4,50	84,10
38-8M-85	38	6F	St	96,77	95,39	103,0	95	105	75	—	15	45	4,90	87,70
40-8M-85	40	6F	GG	101,86	100,49	106,0	95	105	75	—	18	45	5,20	96,70
44-8M-85	44	6F	GG	112,05	110,67	119,0	95	105	75	—	18	45	6,60	108,00
48-8M-85	48	6F	GG	122,23	120,86	127,0	95	105	80	—	18	45	7,60	123,00
56-8M-85	56	6F	GG	142,60	141,23	148,0	95	105	80	—	20	50	9,80	150,00
64-8M-85	64	10WF	GG	162,97	161,60	168,0	95	95	100	137	20	55	10,40	178,00
72-8M-85	72	10WF	GG	183,35	181,97	192,0	95	95	110	158	20	60	11,40	205,00
80-8M-85	80	10A	GG	203,72	202,35	—	95	95	110	180	20	60	11,10	219,00
90-8M-85	90	10A	GG	229,18	227,81	—	95	95	110	204	20	60	13,20	256,00
112-8M-85	112	10A	GG	285,21	283,83	—	95	95	110	260	24	60	16,30	322,00
144-8M-85*	144	10A	GG	366,69	365,32	—	95	95	120	341	24	65	21,50	481,00
168-8M-85*	168	10A	GG	427,81	426,44	—	95	95	120	402	24	65	26,10	516,00
192-8M-85*	192	10A	GG	488,92	487,55	—	95	95	130	463	24	70	30,60	652,00

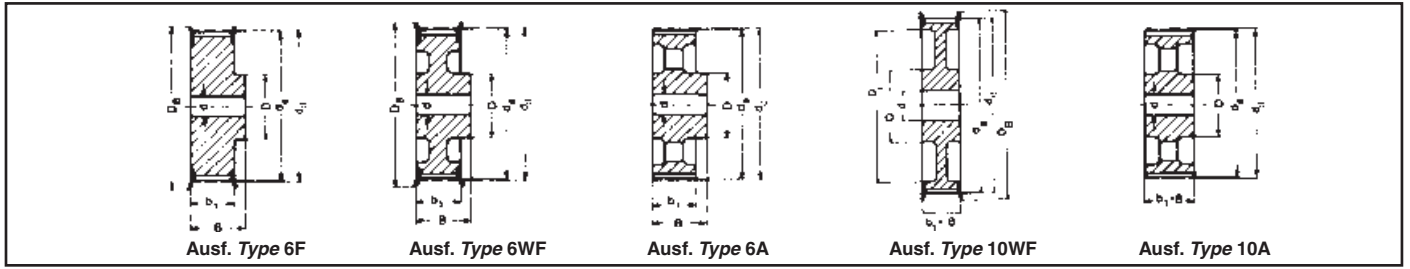

**Type 14M – Teilung Pitch 14 mm für Riemenbreite for belt width 40 mm**

Bezeichnung Part No.	Anzahl der Zähne No. of teeth	Aus- führung Type	Material	d <sub>d</sub> (mm)	d <sub>a</sub> (mm)	D <sub>B</sub> (mm)	b <sub>1</sub> (mm)	B (mm)	D (mm)	D <sub>i</sub> (mm)	Vor- bohrung Pilot bore d (mm)	Fertig- bohrung Finished bore d <sub>max</sub> (mm)	Gewicht Weight (= kg)	€ Stück each
28-14M-40	28	6F	GG	124,78	122,12	127	54	69	100	—	24	60	4,73	<b>92,40</b>
29-14M-40	29	6F	GG	129,23	126,57	138	54	69	100	—	24	60	5,09	<b>99,70</b>
30-14M-40	30	6F	GG	133,69	130,99	138	54	69	100	—	24	60	5,45	<b>106,00</b>
32-14M-40	32	6F	GG	142,60	139,88	154	54	69	100	—	24	70	6,17	<b>114,00</b>
34-14M-40	34	6F	GG	151,52	148,79	160	54	69	100	—	24	70	6,88	<b>126,00</b>
36-14M-40	36	6F	GG	160,43	157,68	168	54	69	100	—	24	70	7,60	<b>138,00</b>
38-14M-40	38	6F	GG	169,34	166,60	183	54	69	120	—	24	70	8,28	<b>141,00</b>
40-14M-40	40	6F	GG	178,25	175,49	188	54	69	120	—	24	70	9,26	<b>159,00</b>
44-14M-40	44	6F	GG	196,08	193,28	211	54	69	120	—	24	70	10,32	<b>172,00</b>
48-14M-40	48	6WF	GG	213,90	211,11	226	54	69	135	172	24	70	11,50	<b>205,00</b>
56-14M-40	56	6WF	GG	249,55	246,76	256	54	69	135	207	28	70	13,05	<b>234,00</b>
64-14M-40	64	6WF	GG	285,21	282,41	296	54	69	135	242	28	70	14,40	<b>280,00</b>
72-14M-40	72	6A	GG	320,86	318,06	—	54	69	135	278	28	70	16,90	<b>290,00</b>
80-14M-40	80	6A	GG	356,51	353,71	—	54	69	135	314	28	70	18,50	<b>298,00</b>
90-14M-40	90	6A	GG	401,07	398,28	—	54	69	135	358	28	70	20,00	<b>335,00</b>
112-14M-40*	112	6A	GG	499,11	496,32	—	54	69	135	456	28	70	26,70	<b>411,00</b>
144-14M-40*	144	6A	GG	641,71	638,92	—	54	69	135	600	28	70	35,00	<b>614,00</b>
168-14M-40*	168	6A	GG	748,66	745,87	—	54	69	135	706	28	70	44,20	<b>808,00</b>
192-14M-40*	192	6A	GG	855,62	852,82	—	54	69	135	813	28	70	52,20	<b>1.035,00</b>
216-14M-40*	216	6A	GG	962,57	959,77	—	54	69	150	920	28	80	60,00	<b>1.195,00</b>

**Type 14M – Teilung Pitch 14 mm für Riemenbreite for belt width 55 mm**

28-14M-55	28	6F	GG	124,78	122,12	127	70	85	100	—	24	60	5,60	<b>115,00</b>
29-14M-55	29	6F	GG	129,23	126,57	138	70	85	100	—	24	60	6,10	<b>121,00</b>
30-14M-55	30	6F	GG	133,69	130,99	138	70	85	100	—	24	60	6,60	<b>125,00</b>
32-14M-55	32	6F	GG	142,60	139,88	154	70	85	100	—	24	70	7,60	<b>134,00</b>
34-14M-55	34	6F	GG	151,52	148,79	160	70	85	100	—	24	70	8,60	<b>143,00</b>
36-14M-55	36	6F	GG	160,43	157,68	168	70	85	100	—	24	70	9,60	<b>157,00</b>
38-14M-55	38	6F	GG	169,34	166,60	183	70	85	120	—	24	70	10,80	<b>168,00</b>
40-14M-55	40	6F	GG	178,25	175,49	188	70	85	120	—	24	70	11,20	<b>182,00</b>
44-14M-55	44	6F	GG	196,08	193,28	211	70	85	120	—	24	70	12,50	<b>198,00</b>
48-14M-55	48	10WF	GG	213,90	211,11	226	70	70	135	172	24	70	13,70	<b>238,00</b>
56-14M-55	56	10WF	GG	249,55	246,76	256	70	70	135	207	28	70	14,50	<b>270,00</b>
64-14M-55	64	10WF	GG	285,21	282,41	296	70	70	135	242	28	70	15,60	<b>318,00</b>
72-14M-55	72	10A	GG	320,86	318,06	—	70	70	135	278	28	70	18,50	<b>326,00</b>
80-14M-55	80	10A	GG	356,51	353,71	—	70	70	135	314	28	70	20,00	<b>356,00</b>
90-14M-55	90	10A	GG	401,07	398,28	—	70	70	135	358	28	70	22,60	<b>403,00</b>
112-14M-55*	112	10A	GG	499,11	496,32	—	70	70	135	456	28	70	29,50	<b>497,00</b>
144-14M-55*	144	10A	GG	641,71	638,92	—	70	70	135	600	28	70	39,00	<b>746,00</b>
168-14M-55*	168	10A	GG	748,66	745,87	—	70	70	135	706	28	70	48,50	<b>969,00</b>
192-14M-55*	192	10A	GG	855,62	852,82	—	70	70	135	813	28	70	57,80	<b>1.157,00</b>
216-14M-55*	216	10A	GG	962,57	959,77	—	70	70	150	920	28	80	67,00	<b>1.411,00</b>

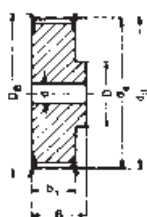

Ausf. Type 6F

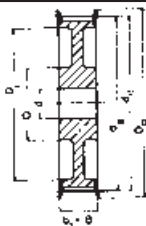

Ausf. Type 10WF



Ausf. Type 10A

**Type 14M – Teilung Pitch 14 mm für Riemenbreite for belt width 85 mm**

Bezeichnung Part No.	Anzahl der Zähne No. of teeth	Aus- führung Type	Material	d <sub>d</sub> (mm)	d <sub>a</sub> (mm)	D <sub>B</sub> (mm)	b <sub>1</sub> (mm)	B (mm)	D (mm)	D <sub>i</sub> (mm)	Vor- bohrung Pilot bore d (mm)	Fertig- bohrung Finished bore d <sub>max</sub> (mm)	Gewicht Weight (= kg)	€ Stück each
28-14M-85	28	6F	GG	124,78	122,12	127	102	117	100	—	24	60	7,70	141,00
29-14M-85	29	6F	GG	129,23	126,57	138	102	117	100	—	24	60	8,40	149,00
30-14M-85	30	6F	GG	133,69	130,99	138	102	117	100	—	24	60	9,10	153,00
32-14M-85	32	6F	GG	142,60	139,88	154	102	117	100	—	24	60	10,50	170,00
34-14M-85	34	6F	GG	151,52	148,79	160	102	117	100	—	24	70	11,90	191,00
36-14M-85	36	6F	GG	160,43	157,68	168	102	117	100	—	32	70	13,20	209,00
38-14M-85	38	6F	GG	169,34	166,60	183	102	117	120	—	32	70	15,15	226,00
40-14M-85	40	6F	GG	178,25	175,49	188	102	117	135	—	32	70	17,10	243,00
44-14M-85	44	6F	GG	196,08	193,28	211	102	117	135	—	32	70	23,30	280,00
48-14M-85	48	6F	GG	213,90	211,11	226	102	117	150	—	32	80	25,00	317,00
56-14M-85	56	10WF	GG	249,55	246,76	256	102	102	150	207	32	80	25,00	369,00
64-14M-85	64	10WF	GG	285,21	282,41	296	102	102	150	242	32	80	28,20	430,00
72-14M-85	72	10A	GG	320,86	318,06	—	102	102	150	278	32	80	28,80	441,00
80-14M-85	80	10A	GG	356,51	353,71	—	102	102	150	314	32	80	30,10	485,00
90-14M-85	90	10A	GG	401,07	398,28	—	102	102	150	358	32	80	33,00	541,00
112-14M-85*	112	10A	GG	499,11	496,32	—	102	102	150	456	32	80	41,80	665,00
144-14M-85*	144	10A	GG	641,71	638,92	—	102	102	150	600	32	80	52,40	951,00
168-14M-85*	168	10A	GG	748,66	745,87	—	102	102	150	706	32	80	60,30	1.270,00
192-14M-85*	192	10A	GG	855,62	852,82	—	102	102	165	813	32	90	70,20	1.511,00
216-14M-85*	216	10A	GG	962,57	959,77	—	102	102	165	920	32	90	81,00	1.859,00

**Type 14M – Teilung Pitch 14 mm für Riemenbreite for belt width 115 mm**

28-14M-115	28	6F	GG	124,78	122,12	127	133	148	100	—	32	60	9,20	177,00
29-14M-115	29	6F	GG	129,23	126,57	138	133	148	100	—	32	60	10,20	190,00
30-14M-115	30	6F	GG	133,69	130,99	138	133	148	100	—	32	60	11,20	198,00
32-14M-115	32	6F	GG	142,60	139,88	154	133	148	100	—	32	60	13,20	214,00
34-14M-115	34	6F	GG	151,52	148,79	160	133	148	100	—	32	70	14,80	243,00
36-14M-115	36	6F	GG	160,43	157,68	168	133	148	120	—	32	70	16,60	271,00
38-14M-115	38	6F	GG	169,34	166,60	183	133	148	120	—	32	70	19,20	290,00
40-14M-115	40	6F	GG	178,25	175,49	188	133	148	135	—	32	70	22,10	306,00
44-14M-115	44	6F	GG	196,08	193,28	211	133	148	140	—	32	80	28,00	356,00
48-14M-115	48	6F	GG	213,90	211,11	226	133	148	150	—	32	80	35,00	395,00
56-14M-115	56	6F	GG	249,55	246,76	256	133	148	150	—	32	80	44,20	479,00
64-14M-115	64	10WF	GG	285,21	282,41	296	133	133	150	242	32	80	36,80	545,00
72-14M-115	72	10A	GG	320,86	318,06	—	133	133	150	278	32	80	36,10	597,00
80-14M-115	80	10A	GG	356,51	353,71	—	133	133	150	314	32	80	38,60	665,00
90-14M-115	90	10A	GG	401,07	398,28	—	133	133	150	358	32	80	41,00	754,00
112-14M-115*	112	10A	GG	499,11	496,32	—	133	133	150	456	32	80	54,40	911,00
144-14M-115*	144	10A	GG	641,71	638,92	—	133	133	165	600	32	90	67,80	1.362,00
168-14M-115*	168	10A	GG	748,66	745,87	—	133	133	165	706	32	90	75,80	1.568,00
192-14M-115*	192	10A	GG	855,62	852,82	—	133	133	165	813	32	90	88,30	1.848,00
216-14M-115*	216	10A	GG	962,57	959,77	—	133	133	165	920	32	90	98,00	2.176,00



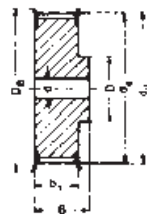

Ausf. Type 6F

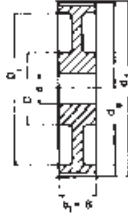

Ausf. Type 10W



Ausf. Type 10A

**Type 14M – Teilung Pitch 14 mm für Riemenbreite for belt width 170 mm**

Bezeichnung Part No.	Anzahl der Zähne No. of teeth	Aus- führung Type	Material	d <sub>d</sub> (mm)	d <sub>a</sub> (mm)	D <sub>B</sub> (mm)	b <sub>1</sub> (mm)	B (mm)	D (mm)	D <sub>i</sub> (mm)	Vor- bohrung Pilot bore d (mm)	Fertig- bohrung Finished bore d <sub>max</sub> (mm)	Gewicht Weight (= kg)	€ Stück each
28-14M-170*	28	6F	GG	124,78	122,12	127	187	202	100	—	32	60	13,80	<b>228,00</b>
29-14M-170*	29	6F	GG	129,23	126,57	138	187	202	100	—	32	60	14,20	<b>256,00</b>
30-14M-170*	30	6F	GG	133,69	130,99	138	187	202	100	—	32	60	15,60	<b>261,00</b>
32-14M-170*	32	6F	GG	142,60	139,88	154	187	202	100	—	32	60	18,10	<b>295,00</b>
34-14M-170*	34	6F	GG	151,52	148,79	160	187	202	100	—	32	60	20,40	<b>348,00</b>
36-14M-170*	36	6F	GG	160,43	157,68	168	187	202	120	—	32	70	23,50	<b>384,00</b>
38-14M-170*	38	6F	GG	169,34	166,60	183	187	202	135	—	32	70	26,50	<b>403,00</b>
40-14M-170*	40	6F	GG	178,25	175,49	188	187	202	140	—	32	85	30,10	<b>430,00</b>
44-14M-170*	44	6F	GG	196,08	193,28	211	187	202	160	—	32	85	37,80	<b>470,00</b>
48-14M-170*	48	6F	GG	213,90	211,11	226	187	202	160	—	32	85	44,50	<b>564,00</b>
56-14M-170*	56	6F	GG	249,55	246,76	256	187	202	160	—	32	85	61,00	<b>702,00</b>
64-14M-170*	64	6F	GG	285,21	282,41	296	187	202	180	—	32	100	81,00	<b>771,00</b>
72-14M-170*	72	10W	GG	320,86	318,06	—	187	187	180	278	32	100	61,40	<b>820,00</b>
80-14M-170*	80	10W	GG	356,51	353,71	—	187	187	180	314	32	100	65,00	<b>1.018,00</b>
90-14M-170*	90	10A	GG	401,07	398,28	—	187	187	180	358	38	100	68,00	<b>1.137,00</b>
112-14M-170*	112	10A	GG	499,11	496,32	—	187	187	200	456	38	110	87,50	<b>1.380,00</b>
144-14M-170*	144	10A	GG	641,71	638,92	—	187	187	220	600	38	120	114,80	<b>1.735,00</b>
168-14M-170*	168	10A	GG	748,66	745,87	—	187	187	220	706	38	120	125,00	<b>2.066,00</b>
192-14M-170*	192	10A	GG	855,62	852,82	—	187	187	220	813	38	120	136,40	<b>2.274,00</b>
216-14M-170*	216	10A	GG	962,57	959,77	—	187	187	220	920	38	120	147,00	<b>2.877,00</b>

**HTD®-Zahnscheiben Type 20M auf Anfrage**  
**HTD® Pulleys type 20M on request**

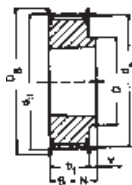

Ausf. Type 8F

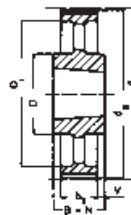

Ausf. Type 7a

**Type 5M – Teilung Pitch 5 mm für Riemenbreite for belt width 15 mm**

Bezeichnung Part No.	Anzahl der Zähne No. of teeth	Aus- führung Type	Mate- rial	d <sub>d</sub> (mm)	d <sub>a</sub> (mm)	D <sub>B</sub> (mm)	b <sub>1</sub> (mm)	B (mm)	N (mm)	V (mm)	Z (mm)	D (mm)	D <sub>i</sub> (mm)	Taper- Buchse Taper bush	Gewicht ohne Buchse Weight without bush (= kg)	€ Stück ohne Buchse each without bush
TB 34-5M-15	34	8F	St	54,11	52,97	57,0	20,5	22	22	1,5	—	43	—	1008	0,190	<b>34,80</b>
TB 36-5M-15	36	8F	St	57,30	56,16	60,0	20,5	22	22	1,5	—	44	—	1108	0,200	<b>35,90</b>
TB 38-5M-15	38	8F	St	69,48	59,34	66,0	20,5	22	22	1,5	—	48	—	1108	0,250	<b>38,40</b>
TB 40-5M-15	40	8F	St	63,66	62,52	71,0	20,5	22	22	1,5	—	52	—	1108	0,310	<b>41,30</b>
TB 44-5M-15	44	8F	St	70,03	68,89	75,0	20,5	22	22	1,5	—	54	—	1108	0,400	<b>44,90</b>
TB 48-5M-15	48	8F	St	76,39	75,25	83,0	20,5	25	25	4,5	—	64	—	1210	0,450	<b>51,10</b>
TB 56-5M-15	56	8F	GG	89,13	87,99	93,0	20,5	25	25	4,5	—	70	—	1210	0,670	<b>55,80</b>
TB 64-5M-15	64	8F	GG	101,86	100,72	106,0	20,5	25	25	4,5	—	78	—	1210	0,960	<b>64,50</b>
TB 72-5M-15	72	8F	GG	114,59	113,45	119,0	20,5	25	25	4,5	—	90	—	1610	1,190	<b>68,20</b>
TB 80-5M-15	80	8F	GG	127,32	126,18	135,0	20,5	25	25	4,5	—	92	—	1610	1,570	<b>73,60</b>
TB 90-5M-15	90	7A	GG	143,24	142,10	—	20,5	25	25	2,3	—	92	—	1610	1,147	<b>76,10</b>
TB 112-5M-15	112	7A	GG	178,25	177,11	—	20,5	25	25	2,3	—	92	—	1610	1,940	<b>88,00</b>
TB 136-5M-15	136	7A	GG	216,45	215,31	—	20,5	32	32	5,8	—	106	—	2012	3,060	<b>106,00</b>
TB 150-5M-15	150	7A	GG	238,73	237,59	—	20,5	32	32	5,8	—	106	—	2012	3,900	<b>131,00</b>

Taper-Buchse Taper bush	1008	1108	1210	1610	2012
Bohrung d <sub>2</sub> (mm) von ... bis ... Bore d <sub>2</sub> (mm) from ... to ...	10-25	10-28	11-32	14-42	14-50
€/Stück each	<b>6,90</b>	<b>7,90</b>	<b>10,40</b>	<b>12,40</b>	<b>15,20</b>

GG = Grauguss Cast iron  
St = Stahl Steel

Fertigungstechnische Änderungen vorbehalten.  
We reserve the right to make technical changes.

Bohrungsdurchmesser d<sub>2</sub> siehe Seite 3.  
Bore diameters d<sub>2</sub> see page 3.

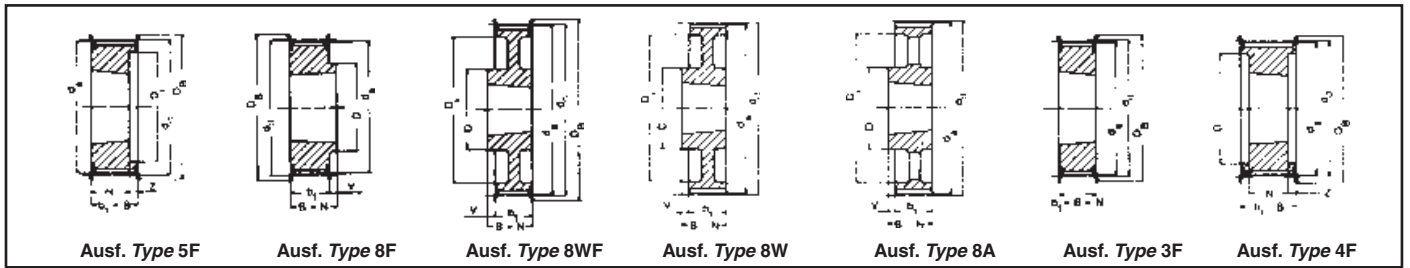

**Type 8M – Teilung Pitch 8 mm für Riemenbreite for belt width 20 mm**

Bezeichnung Part No.	Anzahl der Zähne No. of teeth	Aus- führung Type	Material	d <sub>d</sub> (mm)	d <sub>a</sub> (mm)	D <sub>B</sub> (mm)	b <sub>1</sub> (mm)	B (mm)	N (mm)	V (mm)	Z (mm)	D (mm)	D <sub>i</sub> (mm)	Taper- Buchse Taper bush	Gewicht ohne Buchse Weight without bush (= kg)	€ Stück ohne Buchse each without bush
TB 22-8M-20	22	5F	GG	56,02	54,65	60,0	28	28	22	—	6	—	41	1008	0,24	<b>35,10</b>
TB 24-8M-20	24	5F	GG	61,12	59,75	66,0	28	28	22	—	6	—	42	1108	0,30	<b>35,90</b>
TB 26-8M-20	26	5F	GG	66,21	64,84	71,0	28	28	22	—	6	—	46	1108	0,36	<b>37,40</b>
TB 28-8M-20	28	5F	GG	71,30	70,08	75,0	28	28	22	—	6	—	50	1108	0,44	<b>37,70</b>
TB 30-8M-20	30	5F	GG	76,39	75,13	83,0	28	28	22	—	6	—	58	1108	0,53	<b>39,20</b>
TB 32-8M-20	32	5F	GG	81,49	80,16	87,0	28	28	25	—	3	—	62	1610	0,42	<b>40,20</b>
TB 34-8M-20	34	5F	GG	86,58	85,22	91,0	28	28	25	—	3	—	65	1610	0,55	<b>42,80</b>
TB 36-8M-20	36	5F	GG	91,67	90,30	98,5	28	28	25	—	3	—	68	1610	0,68	<b>44,60</b>
TB 38-8M-20	38	5F	GG	96,77	95,39	103,0	28	28	25	—	3	—	72	1610	0,80	<b>46,70</b>
TB 40-8M-20	40	5F	GG	101,86	100,49	106,0	28	28	25	—	3	—	76	1610	1,00	<b>50,70</b>
TB 44-8M-20	44	8F	GG	112,05	110,67	119,0	28	32	32	4	—	93	—	2012	1,20	<b>56,90</b>
TB 48-8M-20	48	8F	GG	122,23	120,86	127,0	28	32	32	4	—	96	—	2012	1,60	<b>64,50</b>
TB 56-8M-20	56	8F	GG	142,60	141,23	148,0	28	32	32	4	—	110	—	2012	2,40	<b>76,40</b>
TB 64-8M-20	64	8WF	GG	162,97	161,60	168,0	28	32	32	4	—	110	137	2012	2,70	<b>94,90</b>
TB 72-8M-20	72	8WF	GG	183,35	181,97	192,0	28	32	32	4	—	110	158	2012	3,30	<b>112,00</b>
TB 80-8M-20	80	8W	GG	203,72	202,35	—	28	32	32	4	—	110	180	2012	3,50	<b>126,00</b>
TB 90-8M-20	90	8A	GG	229,18	227,81	—	28	32	32	4	—	110	204	2012	3,65	<b>141,00</b>

**Type 8M – Teilung Pitch 8 mm für Riemenbreite for belt width 30 mm**

TB 22-8M-30	22	5F	GG	56,02	54,65	60,0	38	38	22	—	16	—	41	1008	0,29	<b>39,20</b>
TB 24-8M-30	24	5F	GG	61,12	59,75	66,0	38	38	22	—	16	—	42	1108	0,38	<b>39,80</b>
TB 26-8M-30	26	5F	GG	66,21	64,84	71,0	38	38	22	—	16	—	46	1108	0,45	<b>41,60</b>
TB 28-8M-30	28	5F	GG	71,30	70,08	75,0	38	38	25	—	13	—	50	1210	0,50	<b>43,10</b>
TB 30-8M-30	30	3F	GG	76,39	75,13	83,0	38	38	38	—	—	—	—	1615	0,45	<b>44,30</b>
TB 32-8M-30	32	3F	GG	81,49	80,16	87,0	38	38	38	—	—	—	—	1615	0,59	<b>45,30</b>
TB 34-8M-30	34	3F	GG	86,58	85,22	91,0	38	38	38	—	—	—	—	1615	0,77	<b>47,90</b>
TB 36-8M-30	36	3F	GG	91,67	90,30	98,5	38	38	38	—	—	—	—	1615	0,96	<b>49,70</b>
TB 38-8M-30	38	3F	GG	96,77	95,39	103,0	38	38	38	—	—	—	—	1615	1,15	<b>53,90</b>
TB 40-8M-30	40	3F	GG	101,86	100,49	106,0	38	38	38	—	—	—	—	1615	1,34	<b>56,90</b>
TB 44-8M-30	44	4F	GG	112,05	110,67	119,0	38	38	32	—	3	—	91	2012	1,33	<b>65,20</b>
TB 48-8M-30	48	4F	GG	122,23	120,86	127,0	38	38	32	—	3	—	95	2012	1,78	<b>72,80</b>
TB 56-8M-30	56	4F	GG	142,60	141,23	148,0	38	38	32	—	3	—	117	2012	3,76	<b>89,80</b>
TB 64-8M-30	64	8F	GG	162,97	161,60	168,0	38	45	45	7	—	125	—	2517	4,20	<b>107,00</b>
TB 72-8M-30	72	8WF	GG	183,35	181,97	192,0	38	45	45	7	—	125	158	2517	4,30	<b>131,00</b>
TB 80-8M-30	80	8W	GG	203,72	202,35	—	38	45	45	7	—	125	180	2517	4,60	<b>144,00</b>
TB 90-8M-30	90	8A	GG	229,18	227,81	—	38	45	45	7	—	125	204	2517	5,00	<b>167,00</b>
TB 112-8M-30	112	8A	GG	285,21	283,83	—	38	45	45	7	—	125	260	2517	6,20	<b>202,00</b>
TB 144-8M-30	144	8A	GG	366,69	365,32	—	38	45	45	7	—	125	341	2517	9,00	<b>266,00</b>

Taper-Buchse Taper bush	1008	1108	1210	1610	1615	2012	2517
Bohrung d <sub>2</sub> (mm) von ... bis ... Bore d <sub>2</sub> (mm) from ... to ...	10-25	10-28	11-32	14-42	14-42	14-50	16-60
€/Stück each	<b>6,90</b>	<b>7,90</b>	<b>10,40</b>	<b>12,40</b>	<b>13,00</b>	<b>15,20</b>	<b>19,10</b>

GG = Grauguss Cast iron  
Fertigungstechnische Änderungen vorbehalten.  
We reserve the right to make technical changes.  
Bohrungsdurchmesser d<sub>2</sub> siehe Seite 3.  
Bore diameters d<sub>2</sub> see page 3.

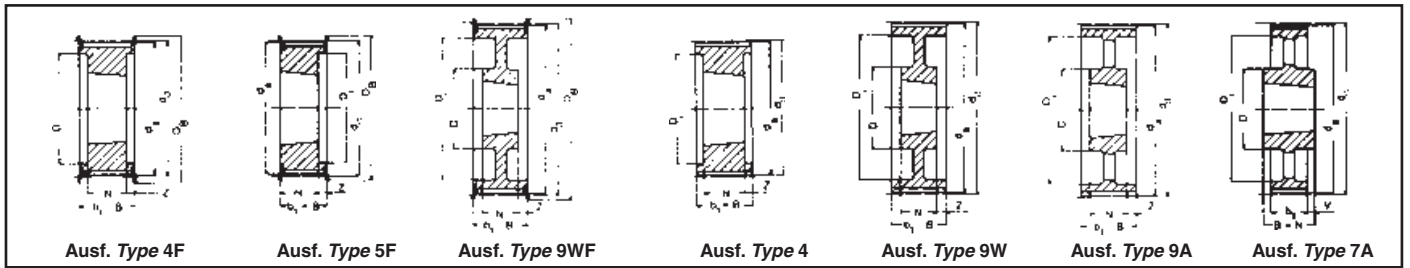

**Type 8M – Teilung Pitch 8 mm für Riemenbreite for belt width 50 mm**

Bezeichnung Part No.	Anzahl der Zähne No. of teeth	Aus- führung Type	Material	d <sub>d</sub> (mm)	d <sub>a</sub> (mm)	D <sub>B</sub> (mm)	b <sub>1</sub> (mm)	B (mm)	N (mm)	V (mm)	Z (mm)	D (mm)	D <sub>i</sub> (mm)	Taper- Buchse Taper bush	Gewicht ohne Buchse Weight without bush (= kg)	€ Stück ohne Buchse each without bush
TB 28-8M-50	28	5F	GG	71,30	70,08	75,0	60	60	25	—	35,0	—	50	1210	0,60	<b>50,30</b>
TB 30-8M-50	30	5F	GG	76,39	75,13	83,0	60	60	38	—	22,0	—	58	1615	0,65	<b>53,90</b>
TB 32-8M-50	32	5F	GG	81,49	80,16	87,0	60	60	38	—	22,0	—	62	1615	0,82	<b>57,60</b>
TB 34-8M-50	34	5F	GG	86,58	85,22	91,0	60	60	38	—	22,0	—	65	1615	1,06	<b>61,60</b>
TB 36-8M-50	36	5F	GG	91,67	90,30	98,5	60	60	38	—	22,0	—	68	1615	1,30	<b>65,90</b>
TB 38-8M-50	38	5F	GG	96,77	95,39	103,0	60	60	38	—	22,0	—	72	1615	1,60	<b>71,00</b>
TB 40-8M-50	40	4F	GG	101,86	100,49	106,0	60	60	32	—	14,0	—	82	2012	1,71	<b>74,60</b>
TB 44-8M-50	44	4F	GG	112,05	110,67	119,0	60	60	32	—	14,0	—	91	2012	1,78	<b>85,90</b>
TB 48-8M-50	48	4F	GG	122,23	120,86	127,0	60	60	32	—	14,0	—	95	2012	2,30	<b>94,90</b>
TB 56-8M-50	56	4F	GG	142,60	141,23	148,0	60	60	45	—	7,5	—	116	2517	3,40	<b>115,00</b>
TB 64-8M-50	64	4F	GG	162,97	161,60	168,0	60	60	45	—	7,5	—	137	2517	5,00	<b>137,00</b>
TB 72-8M-50	72	9WF	GG	183,35	181,97	192,0	60	60	45	—	7,5	125	158	2517	6,70	<b>160,00</b>
TB 80-8M-50	80	4	GG	203,72	202,35	—	60	60	51	—	4,5	—	180	3020	8,80	<b>191,00</b>
TB 90-8M-50	90	9W	GG	229,18	227,81	—	60	60	51	—	4,5	170	204	3020	10,00	<b>217,00</b>
TB 112-8M-50	112	9W	GG	285,21	283,83	—	60	60	51	—	4,5	170	260	3020	12,00	<b>277,00</b>
TB 144-8M-50	144	9A	GG	366,69	365,32	—	60	60	51	—	4,5	170	341	3020	15,20	<b>374,00</b>
TB 168-8M-50	168	7A	GG	427,81	426,44	—	60	65	65	—	2,5	170	402	3525	16,40	<b>493,00</b>
TB 192-8M-50	192	7A	GG	488,92	487,55	—	60	65	65	—	2,5	170	460	3525	21,80	<b>597,00</b>

**Type 8M – Teilung Pitch 8 mm für Riemenbreite for belt width 85 mm**

TB 34-8M-85	34	4F	GG	86,58	85,22	91,0	95	95	38	—	28,5	—	65	1615	1,43	<b>82,30</b>
TB 36-8M-85	36	4F	GG	91,67	90,30	98,5	95	95	38	—	28,5	—	68	1615	1,87	<b>89,80</b>
TB 38-8M-85	38	4F	GG	96,77	95,39	103,0	95	95	38	—	28,5	—	72	1615	2,20	<b>94,90</b>
TB 40-8M-85	40	4F	GG	101,86	100,49	106,0	95	95	32	—	31,5	—	82	2012	1,78	<b>101,00</b>
TB 44-8M-85	44	4F	GG	112,05	110,67	119,0	95	95	32	—	31,5	—	91	2012	2,30	<b>112,00</b>
TB 48-8M-85	48	4F	GG	122,23	120,86	127,0	95	95	45	—	25,0	—	100	2517	2,66	<b>126,00</b>
TB 56-8M-85	56	4F	GG	142,60	141,23	148,0	95	95	45	—	25,0	—	117	2517	4,45	<b>155,00</b>
TB 64-8M-85	64	4F	GG	162,97	161,60	168,0	95	95	45	—	25,0	—	137	2517	6,20	<b>187,00</b>
TB 72-8M-85	72	4F	GG	183,35	181,97	192,0	95	95	51	—	22,0	—	158	3020	8,00	<b>225,00</b>
TB 80-8M-85	80	4	GG	203,72	202,35	—	95	95	51	—	22,0	—	180	3020	10,00	<b>243,00</b>
TB 90-8M-85	90	9W	GG	229,18	227,81	—	95	95	51	—	22,0	170	204	3020	10,80	<b>283,00</b>
TB 112-8M-85	112	9W	GG	285,21	283,83	—	95	95	51	—	22,0	170	260	3020	15,00	<b>366,00</b>
TB 144-8M-85	144	9A	GG	366,69	365,32	—	95	95	76	—	15,0	170	341	3525	20,00	<b>520,00</b>
TB 168-8M-85	168	9A	GG	427,81	426,44	—	95	95	76	—	15,0	170	402	3525	23,00	<b>659,00</b>
TB 192-8M-85	192	9A	GG	488,92	487,55	—	95	95	76	—	15,0	170	460	3525	28,50	<b>749,00</b>

Taper-Buchse Taper bush	1210	1615	2012	2517	3020	3525
Bohrung d <sub>2</sub> (mm) von ... bis ... Bore d <sub>2</sub> (mm) from ... to ...	11-32	14-42	14-50	16-60	25-75	35-90
€/Stück each	<b>10,40</b>	<b>13,00</b>	<b>15,20</b>	<b>19,10</b>	<b>24,80</b>	<b>66,00</b>

GG = Grauguss Cast iron

Fertigungstechnische Änderungen vorbehalten.  
We reserve the right to make technical changes.

Bohrungsdurchmesser d<sub>2</sub> siehe Seite 3.  
Bore diameters d<sub>2</sub> see page 3.

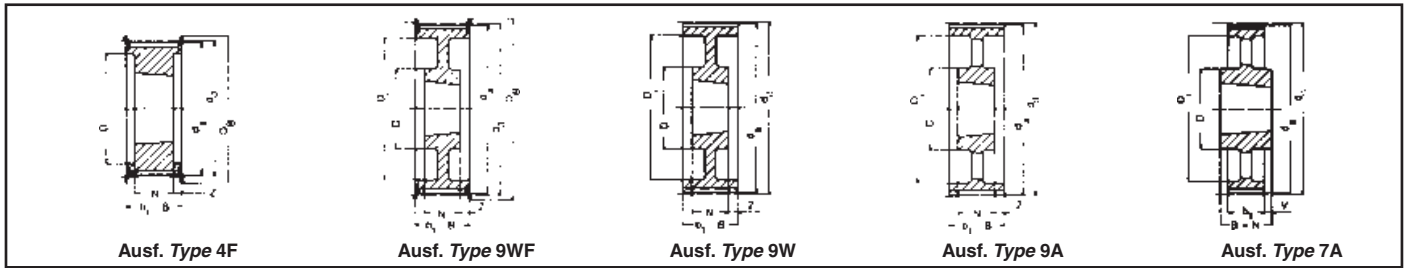

**Type 14M – Teilung Pitch 14 mm für Riemenbreite for belt width 40 mm**

Bezeichnung Part No.	Anzahl der Zähne No. of teeth	Aus- führung Type	Material	d <sub>d</sub> (mm)	d <sub>a</sub> (mm)	D <sub>B</sub> (mm)	b <sub>1</sub> (mm)	B (mm)	N (mm)	V (mm)	Z (mm)	D (mm)	D <sub>i</sub> (mm)	Taper- Buchse Taper bush	Gewicht ohne Buchse Weight without bush (= kg)	€ Stück ohne Buchse each without bush
TB 28-14M-40	28	4F	GG	124,78	122,12	127	54	54	32	—	11,0	—	98	2012	2,00	115,00
TB 29-14M-40	29	4F	GG	129,23	126,57	138	54	54	32	—	11,0	—	100	2012	2,38	119,00
TB 30-14M-40	30	4F	GG	133,69	130,99	138	54	54	32	—	11,0	—	100	2012	2,65	126,00
TB 32-14M-40	32	4F	GG	142,60	139,88	154	54	54	32	—	11,0	—	104	2012	3,40	134,00
TB 34-14M-40	34	4F	GG	151,52	148,79	160	54	54	45	—	4,5	—	110	2517	3,87	141,00
TB 36-14M-40	36	4F	GG	160,43	157,68	168	54	54	45	—	4,5	—	120	2517	4,80	157,00
TB 38-14M-40	38	4F	GG	169,34	166,60	183	54	54	45	—	4,5	—	130	2517	5,40	165,00
TB 40-14M-40	40	4F	GG	178,25	175,49	188	54	54	45	—	4,5	—	138	2517	6,00	177,00
TB 44-14M-40	44	4F	GG	196,08	193,28	211	54	54	51	—	1,5	—	155	3020	7,80	192,00
TB 48-14M-40	48	4F	GG	213,90	211,11	226	54	54	51	—	1,5	—	170	3020	9,40	238,00
TB 56-14M-40	56	9WF	GG	249,55	246,76	256	54	54	51	—	1,5	170	208	3020	10,80	266,00
TB 64-14M-40	64	9WF	GG	285,21	282,41	296	54	54	51	—	1,5	170	242	3020	13,40	280,00
TB 72-14M-40	72	9W	GG	320,86	318,06	—	54	54	51	—	1,5	170	280	3020	15,20	335,00
TB 80-14M-40	80	9A	GG	356,51	353,71	—	54	54	51	—	1,5	170	315	3020	16,00	374,00
TB 90-14M-40	90	9A	GG	401,07	398,28	—	54	54	51	—	1,5	170	360	3020	17,80	448,00
TB 112-14M-40	112	9A	GG	499,11	496,32	—	54	54	51	—	1,5	170	457	3020	25,60	541,00
TB 144-14M-40	144	9A	GG	641,71	638,92	—	54	54	51	—	1,5	170	600	3020	32,00	822,00
TB 168-14M-40	168	9A	GG	748,66	745,87	—	54	54	51	—	1,5	170	706	3020	44,00	877,00
TB 192-14M-40	192	9A	GG	855,62	852,82	—	54	54	51	—	1,5	170	813	3020	49,00	1.074,00
TB 216-14M-40	216	9A	GG	962,57	959,77	—	54	54	51	—	1,5	170	920	3020	55,00	1.369,00

**Type 14M – Teilung Pitch 14 mm für Riemenbreite for belt width 55 mm**

TB 28-14M-55	28	4F	GG	124,78	122,12	127	70	70	32	—	19,0	—	98	2012	2,20	131,00
TB 29-14M-55	29	4F	GG	129,23	126,57	138	70	70	32	—	19,0	—	100	2012	2,74	134,00
TB 30-14M-55	30	4F	GG	133,69	130,99	138	70	70	45	—	12,5	—	100	2517	2,70	141,00
TB 32-14M-55	32	4F	GG	142,60	139,88	154	70	70	45	—	12,5	—	108	2517	3,66	160,00
TB 34-14M-55	34	4F	GG	151,52	148,79	160	70	70	45	—	12,5	—	110	2517	4,55	175,00
TB 36-14M-55	36	4F	GG	160,43	157,68	168	70	70	45	—	12,5	—	120	2517	5,20	187,00
TB 38-14M-55	38	4F	GG	169,34	166,60	183	70	70	45	—	12,5	—	130	2517	6,20	198,00
TB 40-14M-55	40	4F	GG	178,25	175,49	188	70	70	45	—	12,5	—	138	2517	7,00	209,00
TB 44-14M-55	44	4F	GG	196,08	193,28	211	70	70	51	—	9,5	—	155	3020	8,60	236,00
TB 48-14M-55	48	4F	GG	213,90	211,11	226	70	70	51	—	9,5	—	170	3020	10,40	270,00
TB 56-14M-55	56	9WF	GG	249,55	246,76	256	70	70	51	—	9,5	170	208	3020	12,00	322,00
TB 64-14M-55	64	9WF	GG	285,21	282,41	296	70	70	51	—	9,5	170	242	3020	14,50	351,00
TB 72-14M-55	72	9W	GG	320,86	318,06	—	70	70	51	—	9,5	170	280	3020	16,20	380,00
TB 80-14M-55	80	9A	GG	356,51	353,71	—	70	70	51	—	9,5	170	315	3020	17,50	411,00
TB 90-14M-55	90	9A	GG	401,07	398,28	—	70	70	51	—	9,5	170	360	3020	20,10	467,00
TB 112-14M-55	112	9A	GG	499,11	496,32	—	70	70	51	—	9,5	170	457	3020	28,40	597,00
TB 144-14M-55	144	9A	GG	641,71	638,92	—	70	70	51	—	9,5	170	600	3020	36,20	866,00
TB 168-14M-55	168	9A	GG	748,66	745,87	—	70	70	51	—	9,5	170	706	3020	49,00	1.120,00
TB 192-14M-55	192	9A	GG	855,62	852,82	—	70	70	51	—	9,5	170	813	3020	53,00	1.288,00
TB 216-14M-55	216	7A	GG	962,57	959,77	—	70	89	89	9,5	—	190	920	3535	65,80	1.627,00

Taper-Buchse Taper bush	2012	2517	3020	3535
Bohrung d <sub>2</sub> (mm) von ... bis ... Bore d <sub>2</sub> (mm) from ... to ...	14-50	16-60	25-75	35-90
€/Stück each	15,20	19,10	24,80	62,60

GG = Grauguss Cast iron  
Fertigungstechnische Änderungen vorbehalten.  
We reserve the right to make technical changes.  
Bohrungsdurchmesser d<sub>2</sub> siehe Seite 3.  
Bore diameters d<sub>2</sub> see page 3.

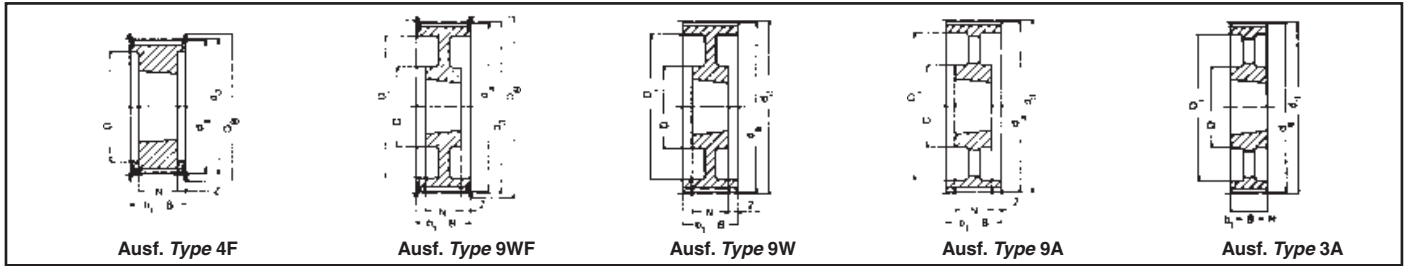

**Type 14M – Teilung Pitch 14 mm für Riemenbreite for belt width 85 mm**

Bezeichnung Part No.	Anzahl der Zähne No. of teeth	Aus- führung Type	Material	d <sub>d</sub> (mm)	d <sub>a</sub> (mm)	D <sub>B</sub> (mm)	b <sub>1</sub> (mm)	B (mm)	N (mm)	V (mm)	Z (mm)	D (mm)	D <sub>i</sub> (mm)	Taper- Buchse Taper bush	Gewicht ohne Buchse Weight without bush (= kg)	€ Stück ohne Buchse each without bush
TB 28-14M-85	28	4F	GG	124,78	122,12	127	102	102	45	—	28,5	—	98	2517	2,70	165,00
TB 29-14M-85	29	4F	GG	129,23	126,57	138	102	102	45	—	28,5	—	100	2517	3,40	169,00
TB 30-14M-85	30	4F	GG	133,69	130,99	138	102	102	45	—	28,5	—	100	2517	3,75	178,00
TB 32-14M-85	32	4F	GG	142,60	139,88	154	102	102	45	—	28,5	—	108	2517	4,80	198,00
TB 34-14M-85	34	4F	GG	151,52	148,79	160	102	102	45	—	28,5	—	110	2517	6,00	225,00
TB 36-14M-85	36	4F	GG	160,43	157,68	168	102	102	51	—	25,5	—	120	3020	5,80	236,00
TB 38-14M-85	38	4F	GG	169,34	166,60	183	102	102	51	—	25,5	—	130	3020	6,80	243,00
TB 40-14M-85	40	4F	GG	178,25	175,49	188	102	102	51	—	25,5	—	138	3020	8,00	261,00
TB 44-14M-85	44	4F	GG	196,08	193,28	211	102	102	76	—	13,0	—	155	3030	11,80	310,00
TB 48-14M-85	48	4F	GG	213,90	211,11	226	102	102	76	—	13,0	—	170	3030	15,10	335,00
TB 56-14M-85	56	4F	GG	249,55	246,76	256	102	102	65	—	18,5	190	210	3525	19,00	411,00
TB 64-14M-85	64	9WF	GG	285,21	282,41	296	102	102	65	—	18,5	190	242	3525	23,00	448,00
TB 72-14M-85	72	9W	GG	320,86	318,06	—	102	102	65	—	18,5	190	280	3525	25,00	485,00
TB 80-14M-85	80	9A	GG	356,51	353,71	—	102	102	65	—	18,5	190	315	3525	26,00	507,00
TB 90-14M-85	90	9A	GG	401,07	398,28	—	102	102	65	—	18,5	190	360	3525	27,80	608,00
TB 112-14M-85	112	9A	GG	499,11	496,32	—	102	102	65	—	18,5	190	457	3525	36,50	822,00
TB 144-14M-85	144	9A	GG	641,71	638,92	—	102	102	65	—	18,5	190	600	3525	48,00	1.045,00
TB 168-14M-85	168	9A	GG	748,66	745,87	—	102	102	65	—	18,5	190	706	3525	60,00	1.307,00
TB 192-14M-85	192	3A	GG	855,62	852,82	—	102	102	102	—	—	230	813	4040	86,00	1.586,00
TB 216-14M-85	216	3A	GG	962,57	959,77	—	102	102	102	—	—	230	920	4040	91,50	2.022,00

**Type 14M – Teilung Pitch 14 mm für Riemenbreite for belt width 115 mm**

TB 28-14M-115	28	4F	GG	124,78	122,12	127	133	133	45	—	44,0	—	98	2517	3,77	231,00
TB 29-14M-115	29	4F	GG	129,23	126,57	138	133	133	45	—	44,0	—	100	2517	4,00	239,00
TB 30-14M-115	30	4F	GG	133,69	130,99	138	133	133	45	—	44,0	—	100	2517	5,00	243,00
TB 32-14M-115	32	4F	GG	142,60	139,88	154	133	133	45	—	44,0	—	108	2517	6,80	261,00
TB 34-14M-115	34	4F	GG	151,52	148,79	160	133	133	45	—	44,0	—	110	2517	6,80	283,00
TB 36-14M-115	36	4F	GG	160,43	157,68	168	133	133	51	—	41,0	—	120	3020	7,00	306,00
TB 38-14M-115	38	4F	GG	169,34	166,60	183	133	133	51	—	41,0	—	130	3020	8,40	332,00
TB 40-14M-115	40	4F	GG	178,25	175,49	188	133	133	51	—	41,0	—	140	3020	9,20	343,00
TB 44-14M-115	44	4F	GG	196,08	193,28	211	133	133	76	—	28,5	—	155	3030	14,00	389,00
TB 48-14M-115	48	4F	GG	213,90	211,11	226	133	133	76	—	28,5	—	170	3030	17,10	502,00
TB 56-14M-115	56	4F	GG	249,55	246,76	256	133	133	89	—	22,0	—	210	3535	24,80	514,00
TB 64-14M-115	64	9WF	GG	285,21	282,41	296	133	133	89	—	22,0	190	242	3535	27,00	559,00
TB 72-14M-115	72	9W	GG	320,86	318,06	—	133	133	89	—	22,0	190	280	3535	29,00	603,00
TB 80-14M-115	80	9A	GG	356,51	353,71	—	133	133	89	—	22,0	190	315	3535	32,00	783,00
TB 90-14M-115	90	9A	GG	401,07	398,28	—	133	133	89	—	22,0	190	360	3535	36,50	859,00
TB 112-14M-115	112	9A	GG	499,11	496,32	—	133	133	89	—	22,0	190	457	3535	46,00	1.056,00
TB 144-14M-115	144	9A	GG	641,71	638,92	—	133	133	102	—	15,5	230	600	4040	68,00	1.323,00
TB 168-14M-115	168	9A	GG	748,66	745,87	—	133	133	102	—	15,5	230	706	4040	82,60	1.660,00
TB 192-14M-115	192	9A	GG	855,62	852,82	—	133	133	102	—	15,5	230	813	4040	96,00	1.940,00
TB 216-14M-115	216	9A	GG	962,57	959,77	—	133	133	102	—	15,5	230	920	4040	107,00	2.460,00

Taper-Buchse Taper bush	2517	3020	3030	3525	3535	4040
Bohrung d <sub>2</sub> (mm) von ... bis ... Bore d <sub>2</sub> (mm) from ... to ...	16-60	25-75	35-75	35-90	35-90	40-100
€/Stück each	19,10	24,80	32,50	66,00	62,60	88,00

GG = Grauguss Cast iron

Fertigungstechnische Änderungen vorbehalten.  
We reserve the right to make technical changes.

Bohrungsdurchmesser d<sub>2</sub> siehe Seite 3.  
Bore diameters d<sub>2</sub> see page 3.

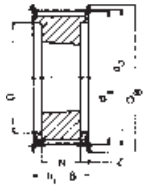

Ausf. Type 4F

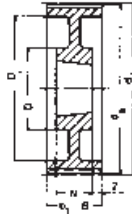

Ausf. Type 9W

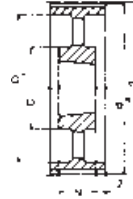

Ausf. Type 9A

**Type 14M – Teilung Pitch 14 mm für Riemenbreite for belt width 170 mm**

Bezeichnung Part No.	Anzahl der Zähne No. of teeth	Aus- führung Type	Mate- rial	d <sub>d</sub> (mm)	d <sub>a</sub> (mm)	D <sub>B</sub> (mm)	b <sub>1</sub> (mm)	B (mm)	N (mm)	V (mm)	Z (mm)	D (mm)	D <sub>i</sub> (mm)	Taper- Buchse Taper bush	Gewicht ohne Buchse Weight without bush (= kg)	€ Stück ohne Buchse each without bush
TB 38-14M-170*	38	4F	GG	169,34	166,60	183	187	187	76	—	55,5	—	130	3030	11,70	<b>482,00</b>
TB 40-14M-170*	40	4F	GG	178,25	175,49	188	187	187	76	—	55,5	—	140	3030	13,00	<b>498,00</b>
TB 44-14M-170*	44	4F	GG	196,08	193,28	211	187	187	89	—	49,0	—	155	3535	15,00	<b>538,00</b>
TB 48-14M-170*	48	4F	GG	213,90	211,11	226	187	187	89	—	49,0	—	175	3535	19,00	<b>667,00</b>
TB 56-14M-170*	56	4F	GG	249,55	246,76	256	187	187	89	—	49,0	—	210	3535	28,50	<b>696,00</b>
TB 64-14M-170*	64	4F	GG	285,21	282,41	296	187	187	102	—	42,5	—	240	4040	41,00	<b>749,00</b>
TB 72-14M-170*	72	9W	GG	320,86	318,06	—	187	187	102	—	42,5	230	280	4040	46,90	<b>817,00</b>
TB 80-14M-170*	80	9W	GG	356,51	353,71	—	187	187	102	—	42,5	230	315	4040	48,00	<b>1.042,00</b>
TB 90-14M-170*	90	9A	GG	401,07	398,28	—	187	187	102	—	42,5	230	360	4040	52,50	<b>1.162,00</b>
TB 112-14M-170*	112	9A	GG	499,11	496,32	—	187	187	127	—	30,0	265	457	5050	74,50	<b>1.415,00</b>
TB 144-14M-170*	144	9A	GG	641,71	638,92	—	187	187	127	—	30,0	265	600	5050	91,00	<b>1.773,00</b>
TB 168-14M-170*	168	9A	GG	748,66	745,87	—	187	187	127	—	30,0	265	706	5050	116,00	<b>2.219,00</b>
TB 192-14M-170*	192	9A	GG	855,62	852,82	—	187	187	127	—	30,0	265	813	5050	134,00	<b>2.595,00</b>
TB 216-14M-170*	216	9A	GG	962,57	959,77	—	187	187	127	—	30,0	265	920	5050	146,50	<b>3.275,00</b>

**HTD®-Zahnscheiben Type 20M auf Anfrage**  
**HTD® Pulleys type 20M on request**

Taper-Buchse Taper bush	3030	3535	4040	5050
Bohrung d <sub>2</sub> (mm) von ... bis ... Bore d <sub>2</sub> (mm) from ... to ...	35-75	35-90	40-100	70-125
€/Stück each	<b>32,50</b>	<b>62,60</b>	<b>88,00</b>	<b>179,00</b>

GG = Grauguss Cast iron

Fertigungstechnische Änderungen vorbehalten.  
 We reserve the right to make technical changes.

\* **Keine Lagerware Non stock items**

Bohrungsdurchmesser d<sub>2</sub> siehe Seite 3.  
 Bore diameters d<sub>2</sub> see page 3.

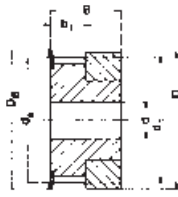

Ausf. Type 1F

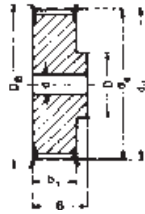

Ausf. Type 6F



Ausf. Type 6

**Type T 2,5 – Teilung Pitch 2,5 mm für Riemenbreite for belt width 4 und and 6 mm**

Bezeichnung Part No.	Anzahl der Zähne No. of teeth	Aus- führung Type	Material	$d_d$ (mm)	$d_a$ (mm)	$D_B$ (mm)	$b_1$ (mm)	B (mm)	D (mm)	$D_i$ (mm)	Vor- bohrung Pilot bore d (mm)	Fertig- bohrung Finished bore $d_{max}$ (mm)	Gewicht Weight (= kg)	€ Stück each
16 T2,5/12-2	12	1F	Al	9,55	9,00	13,0	9	16	12	—	—	3	0,003	10,20
16 T2,5/14-2	14	1F	Al	11,14	10,60	15,0	9	16	14	—	—	4	0,004	10,20
16 T2,5/15-2	15	1F	Al	11,94	11,40	15,0	9	16	15	—	—	4	0,005	10,20
16 T2,5/16-2	16	1F	Al	12,73	12,20	16,0	9	16	16	—	—	5	0,005	10,50
16 T2,5/18-2	18	6F	Al	14,32	13,80	17,5	10	16	9,5	—	4	6	0,006	10,50
16 T2,5/19-2	19	6F	Al	15,12	14,60	18,0	10	16	9,5	—	4	6	0,007	10,80
16 T2,5/20-2	20	6F	Al	15,92	15,40	19,5	10	16	10	—	4	6	0,008	10,80
16 T2,5/22-2	22	6F	Al	17,51	17,00	23,0	10	16	10	—	4	6	0,009	10,80
16 T2,5/24-2	24	6F	Al	19,10	18,55	23,0	10	16	12	—	4	6	0,012	11,30
16 T2,5/25-2	25	6F	Al	19,90	19,35	23,0	10	16	12	—	4	8	0,013	11,30
16 T2,5/26-2	26	6F	Al	20,70	20,15	25,0	10	16	13	—	4	8	0,014	11,60
16 T2,5/28-2	28	6F	Al	22,28	21,75	25,0	10	16	13	—	4	8	0,016	11,60
16 T2,5/30-2	30	6F	Al	23,87	23,35	28,0	10	16	16	—	6	10	0,018	12,00
16 T2,5/32-2	32	6F	Al	25,47	24,95	32,0	10	16	16	—	6	10	0,020	12,00
16 T2,5/36-2	36	6F	Al	28,65	28,10	36,0	10	16	20	—	6	12	0,026	12,30
16 T2,5/40-2	40	6F	Al	31,83	31,30	38,0	10	16	20	—	6	12	0,032	12,60
16 T2,5/44-2	44	6F	Al	35,02	34,50	42,0	10	16	24	—	6	14	0,040	13,10
16 T2,5/48-0	48	6	Al	38,20	37,70	—	10	16	26	—	6	15	0,048	13,40
16 T2,5/60-0	60	6	Al	47,75	47,25	—	10	16	34	—	8	18	0,073	14,40



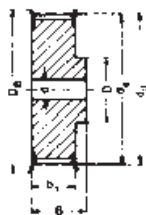

Ausf. Type 6F



Ausf. Type 6

**Type T 5 – Teilung Pitch 5 mm für Riemenbreite for belt width 10 mm**

Bezeichnung Part No.	Anzahl der Zähne No. of teeth	Aus- führung Type	Material	d <sub>d</sub> (mm)	d <sub>a</sub> (mm)	D <sub>B</sub> (mm)	b <sub>1</sub> (mm)	B (mm)	D (mm)	D <sub>i</sub> (mm)	Vor- bohrung Pilot bore d (mm)	Fertig- bohrung Finished bore d <sub>max</sub> (mm)	Gewicht Weight (≈ kg)	€ Stück each
21 T5/10-2	10	6F	Al	15,92	15,05	19,5	15	21	8	—	—	5	0,012	11,60
21 T5/12-2	12	6F	Al	19,01	18,25	23,0	15	21	10	—	—	6	0,016	12,00
21 T5/14-2	14	6F	Al	22,29	21,45	25,0	15	21	13	—	—	8	0,019	12,30
21 T5/15-2	15	6F	Al	23,88	23,05	28,0	15	21	16	—	6	10	0,021	12,60
21 T5/16-2	16	6F	Al	25,47	24,60	32,0	15	21	18	—	6	11	0,025	13,40
21 T5/18-2	18	6F	Al	28,65	27,80	32,0	15	21	19	—	6	12	0,031	15,20
21 T5/19-2	19	6F	Al	30,25	29,40	36,0	15	21	22	—	6	12	0,036	15,60
21 T5/20-2	20	6F	Al	31,83	31,00	36,0	15	21	23	—	6	14	0,038	15,90
21 T5/22-2	22	6F	Al	35,12	34,25	38,0	15	21	24	—	6	15	0,046	16,40
21 T5/24-2	24	6F	Al	38,21	37,40	42,0	15	21	26	—	6	15	0,054	16,70
21 T5/25-2	25	6F	Al	39,80	39,00	44,0	15	21	26	—	6	15	0,058	17,00
21 T5/26-2	26	6F	Al	41,47	40,60	44,0	15	21	26	—	6	16	0,062	17,00
21 T5/27-2	27	6F	Al	42,98	42,20	48,0	15	21	30	—	8	18	0,064	17,40
21 T5/28-2	28	6F	Al	44,62	43,75	48,0	15	21	32	—	8	18	0,071	17,40
21 T5/30-2	30	6F	Al	47,76	46,95	51,0	15	21	34	—	8	18	0,075	17,70
21 T5/32-2	32	6F	Al	50,94	50,10	54,0	15	21	38	—	8	22	0,088	19,20
21 T5/36-2	36	6F	Al	57,31	56,45	63,0	15	21	38	—	8	22	0,114	20,30
21 T5/40-2	40	6F	Al	63,66	62,85	66,0	15	21	40	—	8	23	0,138	22,50
21 T5/42-2	42	6F	Al	66,87	66,00	71,0	15	21	40	—	8	24	0,180	22,80
21 T5/44-0	44	6	Al	70,07	69,20	—	15	21	45	—	8	26	0,185	23,10
21 T5/48-0	48	6	Al	76,42	75,55	—	15	21	50	—	8	28	0,200	26,10
21 T5/60-0	60	6	Al	95,52	94,65	—	15	21	65	—	8	35	0,307	29,70

**Type T 5 – Teilung Pitch 5 mm für Riemenbreite for belt width 16 mm**

27 T5/10-2	10	6F	Al	15,92	15,05	19,5	21	27	8	—	—	5	0,016	12,30
27 T5/12-2	12	6F	Al	19,01	18,25	23,0	21	27	10	—	—	6	0,022	12,60
27 T5/14-2	14	6F	Al	22,29	21,45	25,0	21	27	13	—	—	8	0,026	13,10
27 T5/15-2	15	6F	Al	23,88	23,05	28,0	21	27	16	—	6	10	0,029	13,40
27 T5/16-2	16	6F	Al	25,47	24,60	32,0	21	27	18	—	6	11	0,035	14,40
27 T5/18-2	18	6F	Al	28,65	27,80	32,0	21	27	19	—	6	12	0,043	15,90
27 T5/19-2	19	6F	Al	30,25	29,40	36,0	21	27	22	—	6	12	0,049	16,40
27 T5/20-2	20	6F	Al	31,83	31,00	36,0	21	27	23	—	6	14	0,053	17,00
27 T5/22-2	22	6F	Al	35,12	34,25	38,0	21	27	24	—	6	15	0,054	17,40
27 T5/24-2	24	6F	Al	38,21	37,40	42,0	21	27	26	—	6	15	0,076	17,70
27 T5/25-2	25	6F	Al	39,80	39,00	44,0	21	27	26	—	6	15	0,081	18,20
27 T5/26-2	26	6F	Al	41,47	40,60	44,0	21	27	26	—	6	16	0,085	18,50
27 T5/27-2	27	6F	Al	42,98	42,20	48,0	21	27	30	—	8	18	0,090	19,20
27 T5/28-2	28	6F	Al	44,62	43,75	48,0	21	27	32	—	8	18	0,092	19,50
27 T5/30-2	30	6F	Al	47,76	46,95	51,0	21	27	34	—	8	18	0,105	20,00
27 T5/32-2	32	6F	Al	50,94	50,10	54,0	21	27	38	—	8	22	0,123	21,00
27 T5/36-2	36	6F	Al	57,31	56,45	63,0	21	27	38	—	8	22	0,160	22,50
27 T5/40-2	40	6F	Al	63,66	62,85	66,0	21	27	40	—	8	23	0,193	25,40
27 T5/42-2	42	6F	Al	66,87	66,00	71,0	21	27	40	—	8	24	0,205	25,70
27 T5/44-0	44	6	Al	70,07	69,20	—	21	27	45	—	8	26	0,228	26,40
27 T5/48-0	48	6	Al	76,42	75,55	—	21	27	50	—	8	28	0,280	26,90
27 T5/60-0	60	6	Al	95,52	94,65	—	21	27	65	—	8	35	0,430	31,90

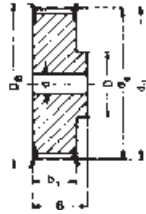

Ausf. Type 6F



Ausf. Type 6

**Type T 5 – Teilung Pitch 5 mm für Riemenbreite for belt width 25 mm**

Bezeichnung Part No.	Anzahl der Zähne No. of teeth	Aus- führung Type	Material	$d_d$ (mm)	$d_a$ (mm)	$D_B$ (mm)	$b_1$ (mm)	B (mm)	D (mm)	$D_i$ (mm)	Vor- bohrung Pilot bore d (mm)	Fertig- bohrung Finished bore $d_{max}$ (mm)	Gewicht Weight (= kg)	€ Stück each
36 T5/10-2	10	6F	Al	15,92	15,05	19,5	30	36	8	—	—	5	0,023	<b>16,70</b>
36 T5/12-2	12	6F	Al	19,01	18,25	23,0	30	36	10	—	—	6	0,031	<b>17,00</b>
36 T5/14-2	14	6F	Al	22,29	21,45	25,0	30	36	13	—	—	8	0,037	<b>17,00</b>
36 T5/15-2	15	6F	Al	23,88	23,05	28,0	30	36	16	—	6	10	0,041	<b>17,40</b>
36 T5/16-2	16	6F	Al	25,47	24,60	32,0	30	36	18	—	6	11	0,050	<b>17,70</b>
36 T5/18-2	18	6F	Al	28,65	27,80	32,0	30	36	19	—	6	12	0,061	<b>18,20</b>
36 T5/19-2	19	6F	Al	30,25	29,40	36,0	30	36	22	—	6	12	0,070	<b>18,50</b>
36 T5/20-2	20	6F	Al	31,83	31,00	36,0	30	36	23	—	6	14	0,076	<b>18,90</b>
36 T5/22-2	22	6F	Al	35,12	34,25	38,0	30	36	24	—	6	15	0,080	<b>20,00</b>
36 T5/24-2	24	6F	Al	38,21	37,40	42,0	30	36	26	—	8	15	0,109	<b>20,30</b>
36 T5/25-2	25	6F	Al	39,80	39,00	44,0	30	36	26	—	8	15	0,116	<b>21,00</b>
36 T5/26-2	26	6F	Al	41,47	40,60	44,0	30	36	26	—	8	16	0,120	<b>21,30</b>
36 T5/27-2	27	6F	Al	42,98	42,20	48,0	30	36	30	—	8	18	0,128	<b>21,80</b>
36 T5/28-2	28	6F	Al	44,62	43,75	48,0	30	36	32	—	8	18	0,135	<b>22,10</b>
36 T5/30-2	30	6F	Al	47,76	46,95	51,0	30	36	34	—	8	18	0,150	<b>22,50</b>
36 T5/32-2	32	6F	Al	50,94	50,10	54,0	30	36	38	—	8	22	0,176	<b>24,30</b>
36 T5/36-2	36	6F	Al	57,31	56,45	63,0	30	36	38	—	8	22	0,230	<b>25,40</b>
36 T5/40-2	40	6F	Al	63,66	62,85	66,0	30	36	40	—	8	23	0,276	<b>27,50</b>
36 T5/42-2	42	6F	Al	66,87	66,00	71,0	30	36	40	—	8	24	0,284	<b>28,00</b>
36 T5/44-0	44	6	Al	70,07	69,20	—	30	36	45	—	8	26	0,315	<b>29,30</b>
36 T5/48-0	48	6	Al	76,42	75,55	—	30	36	50	—	8	28	0,400	<b>31,50</b>
36 T5/60-0	60	6	Al	95,52	94,65	—	30	36	65	—	8	35	0,614	<b>38,40</b>

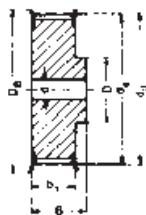

Ausf. Type 6F



Ausf. Type 6

**Type T 10 – Teilung Pitch 10 mm für Riemenbreite for belt width 16 mm**

Bezeichnung Part No.	Anzahl der Zähne No. of teeth	Aus- führung Type	Material	d <sub>d</sub> (mm)	d <sub>a</sub> (mm)	D <sub>B</sub> (mm)	b <sub>1</sub> (mm)	B (mm)	D (mm)	D <sub>i</sub> (mm)	Vor- bohrung Pilot bore d (mm)	Fertig- bohrung Finished bore d <sub>max</sub> (mm)	Gewicht Weight (≈ kg)	€ Stück each
31 T10/12-2	12	6F	Al	38,20	36,35	42	21	31	28	—	6	16	0,076	17,00
31 T10/14-2	14	6F	Al	44,56	42,70	48	21	31	32	—	8	18	0,104	18,20
31 T10/15-2	15	6F	Al	47,75	45,90	51	21	31	32	—	8	18	0,116	18,90
31 T10/16-2	16	6F	Al	50,93	49,05	54	21	31	35	—	8	20	0,134	20,70
31 T10/18-2	18	6F	Al	57,29	55,45	60	21	31	40	—	8	22	0,167	21,80
31 T10/19-2	19	6F	Al	60,48	58,60	66	21	31	44	—	8	22	0,184	23,10
31 T10/20-2	20	6F	Al	63,66	61,80	66	21	31	46	—	8	24	0,208	24,60
31 T10/22-2	22	6F	Al	70,03	68,15	75	21	31	52	—	8	28	0,253	25,70
31 T10/24-2	24	6F	Al	76,39	74,55	83	21	31	58	—	8	30	0,288	29,00
31 T10/25-2	25	6F	Al	79,58	77,70	83	21	31	60	—	8	30	0,310	30,00
31 T10/26-2	26	6F	Al	82,76	80,90	87	21	31	60	—	8	30	0,357	31,50
31 T10/27-2	27	6F	Al	85,95	84,10	91	21	31	60	—	8	30	0,364	33,30
31 T10/28-2	28	6F	Al	89,13	87,25	93	21	31	60	—	8	30	0,401	34,80
31 T10/30-2	30	6F	Al	95,49	93,65	97	21	31	60	—	8	30	0,441	37,70
31 T10/32-2	32	6F	Al	101,86	100,00	106	21	31	65	—	10	32	0,493	44,30
31 T10/36-2	36	6F	Al	114,59	112,75	119	21	31	70	—	10	35	0,623	50,30
31 T10/40-2	40	6F	Al	127,32	125,45	131	21	31	80	—	10	40	0,767	63,40
31 T10/44-0	44	6	Al	140,06	138,20	—	21	31	88	—	10	46	0,993	68,20
31 T10/48-0	48	6	Al	152,78	150,95	—	21	31	95	—	16	48	1,090	75,70
31 T10/60-0	60	6	Al	190,98	189,10	—	21	31	110	—	16	60	1,710	107,00

**Type T 10 – Teilung Pitch 10 mm für Riemenbreite for belt width 25 mm**

40 T10/12-2	12	6F	Al	38,20	36,35	42	30	40	28	—	6	16	0,099	18,90
40 T10/14-2	14	6F	Al	44,56	42,70	48	30	40	32	—	8	18	0,134	21,30
40 T10/15-2	15	6F	Al	47,75	45,90	51	30	40	32	—	8	18	0,152	22,50
40 T10/16-2	16	6F	Al	50,93	49,05	54	30	40	35	—	8	20	0,176	24,30
40 T10/18-2	18	6F	Al	57,29	55,45	60	30	40	40	—	8	22	0,224	26,10
40 T10/19-2	19	6F	Al	60,48	58,60	66	30	40	44	—	8	22	0,247	27,50
40 T10/20-2	20	6F	Al	63,66	61,80	66	30	40	46	—	8	24	0,276	29,00
40 T10/22-2	22	6F	Al	70,03	68,15	75	30	40	52	—	8	28	0,337	30,50
40 T10/24-2	24	6F	Al	76,39	74,55	83	30	40	58	—	8	30	0,392	33,30
40 T10/25-2	25	6F	Al	79,58	77,70	83	30	40	60	—	8	30	0,422	35,10
40 T10/26-2	26	6F	Al	82,76	80,90	87	30	40	60	—	8	30	0,477	36,90
40 T10/27-2	27	6F	Al	85,95	84,10	91	30	40	60	—	8	30	0,536	38,40
40 T10/28-2	28	6F	Al	89,13	87,25	93	30	40	60	—	8	30	0,540	39,80
40 T10/30-2	30	6F	Al	95,49	93,65	97	30	40	60	—	8	30	0,640	43,80
40 T10/32-2	32	6F	Al	101,86	100,00	106	30	40	65	—	10	32	0,693	50,30
40 T10/36-2	36	6F	Al	114,59	112,75	119	30	40	70	—	10	35	0,873	58,70
40 T10/40-2	40	6F	Al	127,32	125,45	131	30	40	80	—	10	40	1,067	73,90
40 T10/44-0	44	6	Al	140,06	138,20	—	30	40	88	—	10	46	1,350	79,00
40 T10/48-0	48	6	Al	152,78	150,95	—	30	40	95	—	16	48	1,516	88,40
40 T10/60-0	60	6	Al	190,98	189,10	—	30	40	110	—	16	60	2,339	115,00

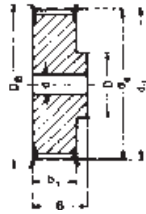

Ausf. Type 6F



Ausf. Type 6

**Type T 10 – Teilung Pitch 10 mm für Riemenbreite for belt width 32 mm**

Bezeichnung Part No.	Anzahl der Zähne No. of teeth	Aus- führung Type	Material	$d_d$ (mm)	$d_a$ (mm)	$D_B$ (mm)	$b_1$ (mm)	B (mm)	D (mm)	$D_i$ (mm)	Vor- bohrung Pilot bore d (mm)	Fertig- bohrung Finished bore $d_{max}$ (mm)	Gewicht Weight (= kg)	€ Stück each
47 T10/18-2	18	6F	Al	57,29	55,45	60	37	47	40	—	10	22	0,253	<b>29,70</b>
47 T10/19-2	19	6F	Al	60,48	58,60	66	37	47	44	—	10	22	0,286	<b>31,90</b>
47 T10/20-2	20	6F	Al	63,66	61,80	66	37	47	46	—	12	24	0,322	<b>34,40</b>
47 T10/22-2	22	6F	Al	70,03	68,15	75	37	47	52	—	12	28	0,393	<b>37,40</b>
47 T10/24-2	24	6F	Al	76,39	74,55	83	37	47	58	—	12	30	0,475	<b>38,80</b>
47 T10/25-2	25	6F	Al	79,58	77,70	83	37	47	60	—	12	30	0,527	<b>41,30</b>
47 T10/26-2	26	6F	Al	82,76	80,90	87	37	47	60	—	12	30	0,564	<b>44,90</b>
47 T10/27-2	27	6F	Al	85,95	84,10	91	37	47	60	—	12	30	0,602	<b>45,70</b>
47 T10/28-2	28	6F	Al	89,13	87,25	93	37	47	60	—	12	30	0,642	<b>46,70</b>
47 T10/30-2	30	6F	Al	95,49	93,65	97	37	47	60	—	12	30	0,740	<b>49,30</b>
47 T10/32-2	32	6F	Al	101,86	100,00	106	37	47	65	—	12	32	0,844	<b>56,20</b>
47 T10/36-2	36	6F	Al	114,59	112,75	119	37	47	70	—	16	35	1,083	<b>66,70</b>
47 T10/40-2	40	6F	Al	127,32	125,45	131	37	47	80	—	16	40	1,317	<b>83,30</b>
47 T10/44-0	44	6	Al	140,06	138,20	—	37	47	88	—	16	46	1,611	<b>91,70</b>
47 T10/48-0	48	6	Al	152,78	150,95	—	37	47	95	—	16	48	1,931	<b>102,00</b>
47 T10/60-0	60	6	Al	190,98	189,10	—	37	47	110	—	16	60	3,004	<b>134,00</b>

**Type T 10 – Teilung Pitch 10 mm für Riemenbreite for belt width 50 mm**

66 T10/18-2	18	6F	Al	57,29	55,45	60	56	66	40	—	10	22	0,422	<b>34,40</b>
66 T10/19-2	19	6F	Al	60,48	58,60	66	56	66	44	—	10	22	0,466	<b>36,90</b>
66 T10/20-2	20	6F	Al	63,66	61,80	66	56	66	46	—	12	24	0,520	<b>39,20</b>
66 T10/22-2	22	6F	Al	70,03	68,15	75	56	66	52	—	12	28	0,570	<b>43,50</b>
66 T10/24-2	24	6F	Al	76,39	74,55	83	56	66	58	—	12	30	0,736	<b>47,90</b>
66 T10/25-2	25	6F	Al	79,58	77,70	83	56	66	60	—	12	30	0,766	<b>49,70</b>
66 T10/26-2	26	6F	Al	82,76	80,90	87	56	66	60	—	12	30	0,816	<b>51,50</b>
66 T10/27-2	27	6F	Al	85,95	84,10	91	56	66	60	—	12	30	0,946	<b>53,60</b>
66 T10/28-2	28	6F	Al	89,13	87,25	93	56	66	60	—	12	30	0,960	<b>55,10</b>
66 T10/30-2	30	6F	Al	95,49	93,65	97	56	66	60	—	12	30	1,169	<b>60,80</b>
66 T10/32-2	32	6F	Al	101,86	100,00	106	56	66	65	—	12	32	1,300	<b>67,40</b>
66 T10/36-2	36	6F	Al	114,59	112,75	119	56	66	70	—	16	35	1,637	<b>85,90</b>
66 T10/40-2	40	6F	Al	127,32	125,45	131	56	66	80	—	16	40	1,999	<b>97,10</b>
66 T10/44-0	44	6	Al	140,06	138,20	—	56	66	88	—	16	46	2,357	<b>112,00</b>
66 T10/48-0	48	6	Al	152,78	150,95	—	56	66	95	—	16	48	2,830	<b>123,00</b>
66 T10/60-0	60	6	Al	190,98	189,10	—	56	66	110	—	16	60	4,366	<b>175,00</b>

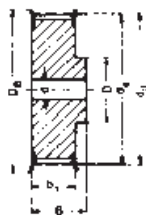

Ausf. Type 6F



Ausf. Type 6

**Type AT 5 – Teilung Pitch 5 mm für Riemenbreite for belt width 10 mm**

Bezeichnung Part No.	Anzahl der Zähne No. of teeth	Aus- führung Type	Material	d <sub>d</sub> (mm)	d <sub>a</sub> (mm)	D <sub>B</sub> (mm)	b <sub>1</sub> (mm)	B (mm)	D (mm)	Vor- bohrung Pilot bore d (mm)	Fertig- bohrung Finished bore d <sub>max</sub> (mm)	Gewicht Weight (= kg)	€ Stück each
21 AT 5/12-2	12	6F	Al	19,01	17,85	23,0	15	21	10	—	6	0,016	14,40
21 AT 5/14-2	14	6F	Al	22,29	21,05	25,0	15	21	13	—	8	0,019	15,20
21 AT 5/15-2	15	6F	Al	23,88	22,65	28,0	15	21	16	6	10	0,021	15,60
21 AT 5/16-2	16	6F	Al	25,47	24,20	32,0	15	21	18	6	11	0,025	16,40
21 AT 5/18-2	18	6F	Al	28,65	27,40	32,0	15	21	19	6	12	0,031	18,20
21 AT 5/19-2	19	6F	Al	30,25	29,00	36,0	15	21	22	6	12	0,036	18,50
21 AT 5/20-2	20	6F	Al	31,83	30,60	36,0	15	21	23	6	14	0,038	18,90
21 AT 5/22-2	22	6F	Al	35,12	33,85	38,0	15	21	24	6	15	0,046	19,50
21 AT 5/24-2	24	6F	Al	38,21	37,00	42,0	15	21	26	6	15	0,054	20,00
21 AT 5/25-2	25	6F	Al	39,80	38,60	44,0	15	21	26	6	15	0,058	20,30
21 AT 5/26-2	26	6F	Al	41,47	40,20	44,0	15	21	26	6	16	0,062	20,30
21 AT 5/27-2	27	6F	Al	42,98	41,80	48,0	15	21	30	8	18	0,064	20,50
21 AT 5/28-2	28	6F	Al	44,62	43,35	48,0	15	21	32	8	18	0,071	20,80
21 AT 5/30-2	30	6F	Al	47,76	46,55	51,0	15	21	34	8	18	0,075	21,00
21 AT 5/32-2	32	6F	Al	50,94	49,70	54,0	15	21	38	8	22	0,088	22,80
21 AT 5/36-2	36	6F	Al	57,31	56,05	63,0	15	21	38	8	22	0,114	24,60
21 AT 5/40-2	40	6F	Al	63,66	62,45	66,0	15	21	40	8	23	0,138	27,20
21 AT 5/42-2	42	6F	Al	66,87	65,60	71,0	15	21	40	8	24	0,180	27,50
21 AT 5/44-0	44	6	Al	70,07	68,80	—	15	21	45	8	26	0,185	27,90
21 AT 5/48-0	48	6	Al	76,42	75,15	—	15	21	50	8	28	0,200	31,20
21 AT 5/60-0	60	6	Al	95,52	94,25	—	15	21	65	8	35	0,307	35,90

**Type AT 5 – Teilung Pitch 5 mm für Riemenbreite for belt width 16 mm**

27 AT 5/12-2	12	6F	Al	19,01	17,85	23,0	21	27	10	—	6	0,022	15,60
27 AT 5/14-2	14	6F	Al	22,29	21,05	25,0	21	27	13	—	8	0,026	15,90
27 AT 5/15-2	15	6F	Al	23,88	22,65	28,0	21	27	16	6	10	0,029	16,40
27 AT 5/16-2	16	6F	Al	25,47	24,20	32,0	21	27	18	6	11	0,035	17,40
27 AT 5/18-2	18	6F	Al	28,65	27,40	32,0	21	27	19	6	12	0,043	18,90
27 AT 5/19-2	19	6F	Al	30,25	29,00	36,0	21	27	22	6	12	0,049	19,50
27 AT 5/20-2	20	6F	Al	31,83	30,60	36,0	21	27	23	6	14	0,053	20,30
27 AT 5/22-2	22	6F	Al	35,12	33,85	38,0	21	27	24	6	15	0,054	20,70
27 AT 5/24-2	24	6F	Al	38,21	37,00	42,0	21	27	26	6	15	0,076	21,00
27 AT 5/25-2	25	6F	Al	39,80	38,60	44,0	21	27	26	6	15	0,081	21,80
27 AT 5/26-2	26	6F	Al	41,47	40,20	44,0	21	27	26	6	16	0,085	22,10
27 AT 5/27-2	27	6F	Al	42,98	41,80	48,0	21	27	30	8	18	0,090	22,80
27 AT 5/28-2	28	6F	Al	44,62	43,35	48,0	21	27	32	8	18	0,092	23,10
27 AT 5/30-2	30	6F	Al	47,76	46,55	51,0	21	27	34	8	18	0,105	24,30
27 AT 5/32-2	32	6F	Al	50,94	49,70	54,0	21	27	38	8	22	0,123	25,40
27 AT 5/36-2	36	6F	Al	57,31	56,05	63,0	21	27	38	8	22	0,160	27,20
27 AT 5/40-2	40	6F	Al	63,66	62,45	66,0	21	27	40	8	23	0,193	30,00
27 AT 5/42-2	42	6F	Al	66,87	65,60	71,0	21	27	40	8	24	0,205	30,00
27 AT 5/44-0	44	6	Al	70,07	68,80	—	21	27	45	8	26	0,228	31,50
27 AT 5/48-0	48	6	Al	76,42	75,15	—	21	27	50	8	28	0,280	31,90
27 AT 5/60-0	60	6	Al	95,52	94,25	—	21	27	65	8	35	0,430	38,40

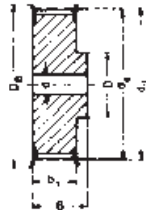

Ausf. Type 6F



Ausf. Type 6

**Type AT 5 – Teilung Pitch 5 mm für Riemenbreite for belt width 25 mm**

Bezeichnung Part No.	Anzahl der Zähne No. of teeth	Aus- führung Type	Material	d <sub>d</sub> (mm)	d <sub>a</sub> (mm)	D <sub>B</sub> (mm)	b <sub>1</sub> (mm)	B (mm)	D (mm)	Vor- bohrung Pilot bore d (mm)	Fertig- bohrung Finished bore d <sub>max</sub> (mm)	Gewicht Weight (= kg)	€ Stück each
36 AT 5/12-2	12	6F	Al	19,01	17,85	23,0	30	36	10	—	6	0,031	<b>20,30</b>
36 AT 5/14-2	14	6F	Al	22,29	21,05	25,0	30	36	13	—	8	0,037	<b>20,30</b>
36 AT 5/15-2	15	6F	Al	23,88	22,65	28,0	30	36	16	6	10	0,041	<b>20,70</b>
36 AT 5/16-2	16	6F	Al	25,47	24,20	32,0	30	36	18	6	11	0,050	<b>21,00</b>
36 AT 5/18-2	18	6F	Al	28,65	27,40	32,0	30	36	19	6	12	0,061	<b>21,80</b>
36 AT 5/19-2	19	6F	Al	30,25	29,00	36,0	30	36	22	6	12	0,070	<b>22,10</b>
36 AT 5/20-2	20	6F	Al	31,83	30,60	36,0	30	36	23	6	14	0,076	<b>22,50</b>
36 AT 5/22-2	22	6F	Al	35,12	33,85	38,0	30	36	24	6	15	0,080	<b>24,30</b>
36 AT 5/24-2	24	6F	Al	38,21	37,00	42,0	30	36	26	8	15	0,109	<b>24,60</b>
36 AT 5/25-2	25	6F	Al	39,80	38,60	44,0	30	36	26	8	15	0,116	<b>25,40</b>
36 AT 5/26-2	26	6F	Al	41,47	40,20	44,0	30	36	26	8	16	0,120	<b>25,70</b>
36 AT 5/27-2	27	6F	Al	42,98	41,80	48,0	30	36	30	8	18	0,128	<b>26,40</b>
36 AT 5/28-2	28	6F	Al	44,62	43,35	48,0	30	36	32	8	18	0,135	<b>26,90</b>
36 AT 5/30-2	30	6F	Al	47,76	46,55	51,0	30	36	34	8	18	0,150	<b>27,20</b>
36 AT 5/32-2	32	6F	Al	50,94	49,70	54,0	30	36	38	8	22	0,176	<b>29,00</b>
36 AT 5/36-2	36	6F	Al	57,31	56,05	63,0	30	36	38	8	22	0,230	<b>30,00</b>
36 AT 5/40-2	40	6F	Al	63,66	62,45	66,0	30	36	40	8	23	0,276	<b>33,30</b>
36 AT 5/42-2	42	6F	Al	66,87	65,60	71,0	30	36	40	8	24	0,284	<b>33,70</b>
36 AT 5/44-0	44	6	Al	70,07	68,80	—	30	36	45	8	26	0,315	<b>35,60</b>
36 AT 5/48-0	48	6	Al	76,42	75,15	—	30	36	50	8	28	0,400	<b>38,00</b>
36 AT 5/60-0	60	6	Al	95,52	94,25	—	30	36	65	8	35	0,614	<b>46,00</b>

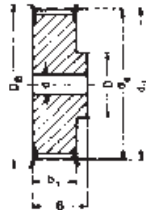

Ausf. Type 6F



Ausf. Type 6

**Type AT 10 – Teilung Pitch 10 mm für Riemenbreite for belt width 16 mm**

Bezeichnung Part No.	Anzahl der Zähne No. of teeth	Aus- führung Type	Material	d <sub>d</sub> (mm)	d <sub>a</sub> (mm)	D <sub>B</sub> (mm)	b <sub>1</sub> (mm)	B (mm)	D (mm)	Vor- bohrung Pilot bore d (mm)	Fertig- bohrung Finished bore d <sub>max</sub> (mm)	Gewicht Weight (= kg)	€ Stück each
31 AT 10/15-2	15	6F	Al	47,75	45,90	51	21	31	32	8	18	0,116	22,50
31 AT 10/16-2	16	6F	Al	50,93	49,05	54	21	31	35	8	20	0,134	25,10
31 AT 10/18-2	18	6F	Al	57,29	55,45	60	21	31	40	8	22	0,167	26,40
31 AT 10/19-2	19	6F	Al	60,48	58,60	66	21	31	44	8	22	0,184	27,90
31 AT 10/20-2	20	6F	Al	63,66	61,80	66	21	31	46	8	24	0,208	29,30
31 AT 10/22-2	22	6F	Al	70,03	68,15	75	21	31	52	8	28	0,253	30,80
31 AT 10/24-2	24	6F	Al	76,39	74,55	83	21	31	58	8	30	0,288	34,80
31 AT 10/25-2	25	6F	Al	79,58	77,70	83	21	31	60	8	30	0,310	36,20
31 AT 10/26-2	26	6F	Al	82,76	80,90	87	21	31	60	8	30	0,357	38,00
31 AT 10/27-2	27	6F	Al	85,95	84,10	91	21	31	60	8	30	0,364	39,80
31 AT 10/28-2	28	6F	Al	89,13	87,25	93	21	31	60	8	30	0,401	41,30
31 AT 10/30-2	30	6F	Al	95,49	93,65	97	21	31	60	8	30	0,441	45,30
31 AT 10/32-2	32	6F	Al	101,86	100,00	106	21	31	65	10	32	0,493	52,90
31 AT 10/36-2	36	6F	Al	114,59	112,75	119	21	31	70	10	35	0,623	60,50
31 AT 10/40-2	40	6F	Al	127,32	125,45	131	21	31	80	10	40	0,767	76,10
31 AT 10/44-0	44	6	Al	140,06	138,20	—	21	31	88	10	46	0,993	81,90
31 AT 10/48-0	48	6	Al	152,78	150,95	—	21	31	95	16	48	1,090	91,00
31 AT 10/60-0	60	6	Al	190,98	189,10	—	21	31	110	16	60	1,710	129,00

**Type AT 10 – Teilung Pitch 10 mm für Riemenbreite for belt width 25 mm**

40 AT 10/15-2	15	6F	Al	47,75	45,90	51	30	40	32	8	18	0,152	27,20
40 AT 10/16-2	16	6F	Al	50,93	49,05	54	30	40	35	8	20	0,176	29,00
40 AT 10/18-2	18	6F	Al	57,29	55,45	60	30	40	40	8	22	0,224	31,20
40 AT 10/19-2	19	6F	Al	60,48	58,60	66	30	40	44	8	22	0,247	33,30
40 AT 10/20-2	20	6F	Al	63,66	61,80	66	30	40	46	8	24	0,276	34,80
40 AT 10/22-2	22	6F	Al	70,03	68,15	75	30	40	52	8	28	0,337	36,60
40 AT 10/24-2	24	6F	Al	76,39	74,55	83	30	40	58	8	30	0,392	39,80
40 AT 10/25-2	25	6F	Al	79,58	77,70	83	30	40	60	8	30	0,422	42,00
40 AT 10/26-2	26	6F	Al	82,76	80,90	87	30	40	60	8	30	0,477	44,60
40 AT 10/27-2	27	6F	Al	85,95	84,10	91	30	40	60	8	30	0,536	46,00
40 AT 10/28-2	28	6F	Al	89,13	87,25	93	30	40	60	8	30	0,540	47,90
40 AT 10/30-2	30	6F	Al	95,49	93,65	97	30	40	60	8	30	0,640	52,60
40 AT 10/32-2	32	6F	Al	101,86	100,00	106	30	40	65	10	32	0,693	60,50
40 AT 10/36-2	36	6F	Al	114,59	112,75	119	30	40	70	10	35	0,873	70,30
40 AT 10/40-2	40	6F	Al	127,32	125,45	131	30	40	80	10	40	1,067	88,40
40 AT 10/44-0	44	6	Al	140,06	138,20	—	30	40	88	10	46	1,350	94,90
40 AT 10/48-0	48	6	Al	152,78	150,95	—	30	40	95	16	48	1,516	106,00
40 AT 10/60-0	60	6	Al	190,98	189,10	—	30	40	110	16	60	2,339	139,00

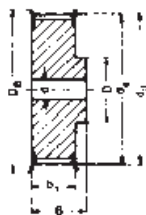

Ausf. Type 6F



Ausf. Type 6

**Type AT 10 – Teilung Pitch 10 mm für Riemenbreite for belt width 32 mm**

Bezeichnung Part No.	Anzahl der Zähne No. of teeth	Aus- führung Type	Material	d <sub>d</sub> (mm)	d <sub>a</sub> (mm)	D <sub>B</sub> (mm)	b <sub>1</sub> (mm)	B (mm)	D (mm)	Vor- bohrung Pilot bore d (mm)	Fertig- bohrung Finished bore d <sub>max</sub> (mm)	Gewicht Weight (= kg)	€ Stück each
47 AT 10/18-2	18	6F	Al	57,29	55,45	60	37	47	40	10	22	0,253	<b>35,90</b>
47 AT 10/19-2	19	6F	Al	60,48	58,60	66	37	47	44	10	22	0,286	<b>38,40</b>
47 AT 10/20-2	20	6F	Al	63,66	61,80	66	37	47	46	12	24	0,322	<b>41,00</b>
47 AT 10/22-2	22	6F	Al	70,03	68,15	75	37	47	52	12	28	0,393	<b>44,90</b>
47 AT 10/24-2	24	6F	Al	76,39	74,55	83	37	47	58	12	30	0,475	<b>46,70</b>
47 AT 10/25-2	25	6F	Al	79,58	77,70	83	37	47	60	12	30	0,527	<b>49,70</b>
47 AT 10/26-2	26	6F	Al	82,76	80,90	87	37	47	60	12	30	0,564	<b>53,90</b>
47 AT 10/27-2	27	6F	Al	85,95	84,10	91	37	47	60	12	30	0,602	<b>54,70</b>
47 AT 10/28-2	28	6F	Al	89,13	87,25	93	37	47	60	12	30	0,642	<b>56,20</b>
47 AT 10/30-2	30	6F	Al	95,49	93,65	97	37	47	60	12	30	0,740	<b>59,00</b>
47 AT 10/32-2	32	6F	Al	101,86	100,00	106	37	47	65	12	32	0,844	<b>67,40</b>
47 AT 10/36-2	36	6F	Al	114,59	112,75	119	37	47	70	16	35	1,083	<b>79,70</b>
47 AT 10/40-2	40	6F	Al	127,32	125,45	131	37	47	80	16	40	1,317	<b>100,00</b>
47 AT 10/44-0	44	6	Al	140,06	138,20	—	37	47	88	16	46	1,611	<b>110,00</b>
47 AT 10/48-0	48	6	Al	152,78	150,95	—	37	47	95	16	48	1,931	<b>122,00</b>
47 AT 10/60-0	60	6	Al	190,98	189,10	—	37	47	110	16	60	3,004	<b>160,00</b>

**Type AT 10 – Teilung Pitch 10 mm für Riemenbreite for belt width 50 mm**

66 AT 10/18-2	18	6F	Al	57,29	55,45	60	56	66	40	10	22	0,422	<b>41,00</b>
66 AT 10/19-2	19	6F	Al	60,48	58,60	66	56	66	44	10	22	0,466	<b>44,60</b>
66 AT 10/20-2	20	6F	Al	63,66	61,80	66	56	66	46	12	24	0,520	<b>47,10</b>
66 AT 10/22-2	22	6F	Al	70,03	68,15	75	56	66	52	12	28	0,570	<b>52,20</b>
66 AT 10/24-2	24	6F	Al	76,39	74,55	83	56	66	58	12	30	0,736	<b>57,20</b>
66 AT 10/25-2	25	6F	Al	79,58	77,70	83	56	66	60	12	30	0,766	<b>59,40</b>
66 AT 10/26-2	26	6F	Al	82,76	80,90	87	56	66	60	12	30	0,816	<b>62,00</b>
66 AT 10/27-2	27	6F	Al	85,95	84,10	91	56	66	60	12	30	0,946	<b>64,10</b>
66 AT 10/28-2	28	6F	Al	89,13	87,25	93	56	66	60	12	30	0,960	<b>65,90</b>
66 AT 10/30-2	30	6F	Al	95,49	93,65	97	56	66	60	12	30	1,169	<b>73,10</b>
66 AT 10/32-2	32	6F	Al	101,86	100,00	106	56	66	65	12	32	1,300	<b>81,10</b>
66 AT 10/36-2	36	6F	Al	114,59	112,75	119	56	66	70	16	35	1,637	<b>103,00</b>
66 AT 10/40-2	40	6F	Al	127,32	125,45	131	56	66	80	16	40	1,999	<b>116,00</b>
66 AT 10/44-0	44	6	Al	140,06	138,20	—	56	66	88	16	46	2,357	<b>135,00</b>
66 AT 10/48-0	48	6	Al	152,78	150,95	—	56	66	95	16	48	2,830	<b>149,00</b>
66 AT 10/60-0	60	6	Al	190,98	189,10	—	56	66	110	16	60	4,366	<b>210,00</b>



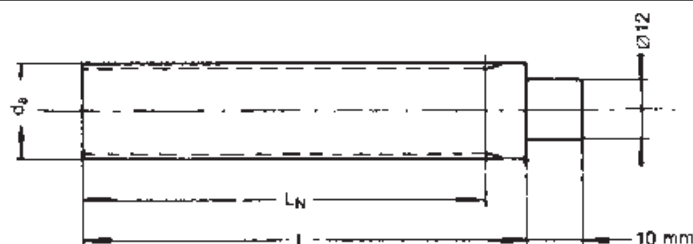

**Type XL – Teilung Pitch 5,08 mm (1/5")**

Bezeichnung Part No.	Anzahl der Zähne No. of teeth	Material	d <sub>d</sub> (mm)	d <sub>a</sub> (mm)	L <sub>N</sub> (mm)	L (mm)	€ Stück each
10 XL 125	10	St	16,17	15,66	125	140	23,80
11 XL 125	11	St	17,79	17,28	125	140	24,00
12 XL 125	12	St	19,40	18,89	125	140	26,80
13 XL 125	13	St	21,02	20,51	125	140	28,80
14 XL 132	14	St	22,64	22,13	132	140	31,00
15 XL 132	15	St	24,26	23,75	132	140	31,90
16 XL 140	16	St	25,87	25,36	140	140	34,40
17 XL 140	17	St	27,49	26,98	140	140	36,80
18 XL 140	18	St	29,11	28,60	140	140	37,10
19 XL 140	19	St	30,72	30,21	140	140	40,60
20 XL 140	20	St	32,34	31,83	140	140	44,30
21 XL 160	21	St	33,96	33,45	160	160	46,00
22 XL 160	22	St	35,57	35,06	160	160	48,10
23 XL 160	23	St	37,19	36,68	160	160	50,50
24 XL 160	24	St	38,81	38,30	160	160	53,00
25 XL 160	25	St	40,43	39,92	160	160	58,40
26 XL 160	26	St	42,04	41,53	160	160	62,00
27 XL 160	27	St	43,66	43,15	160	160	64,50
28 XL 160	28	St	45,28	44,77	160	160	66,60
29 XL 160	29	St	46,89	46,38	160	160	68,50
30 XL 160	30	St	48,51	48,00	160	160	70,40
32 XL 160	32	Al	51,74	51,23	160	160	85,90
33 XL 160	33	Al	53,36	52,76	160	160	91,00
34 XL 160	34	Al	54,98	54,47	160	160	97,10
35 XL 160	35	Al	56,60	56,09	160	160	98,90
36 XL 160	36	Al	58,21	57,70	160	160	102,00
38 XL 160	38	Al	61,45	60,94	160	160	112,00
39 XL 160	39	Al	63,06	62,55	160	160	119,00
40 XL 160	40	Al	64,68	64,17	160	160	126,00
41 XL 160	41	Al	66,30	65,79	160	160	131,00
42 XL 160	42	Al	67,91	67,40	160	160	131,00
43 XL 160	43	Al	69,53	69,02	160	160	140,00
44 XL 160	44	Al	71,15	70,64	160	160	142,00
48 XL 160	48	Al	77,62	77,11	160	160	161,00
56 XL 160	56	Al	90,55	90,04	160	160	188,00
60 XL 160	60	Al	97,02	96,51	160	160	219,00
72 XL 160	72	Al	116,43	115,92	160	160	322,00

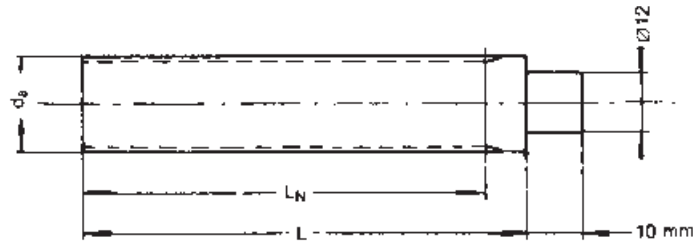

**Type L – Teilung *Pitch* 9,525 mm ( $3/8''$ )**

Bezeichnung Part No.	Anzahl der Zähne No. of teeth	Material	$d_d$ (mm)	$d_a$ (mm)	$L_N$ (mm)	L (mm)	€ Stück each
10 L 140	10	St	30,32	29,56	140	140	30,50
11 L 140	11	St	33,35	32,59	140	140	34,10
12 L 160	12	St	36,38	35,62	160	160	36,40
13 L 160	13	St	39,41	38,65	160	160	40,20
14 L 160	14	St	42,45	41,68	160	160	40,70
15 L 160	15	St	45,48	44,72	160	160	44,10
16 L 160	16	St	48,51	47,75	160	160	49,00
17 L 160	17	St	51,54	50,78	160	160	57,00
18 L 160	18	St	54,57	53,81	160	160	60,40
19 L 160	19	St	57,61	56,84	160	160	61,30
20 L 160	20	St	60,64	59,88	160	160	65,60
21 L 160	21	St	63,67	62,91	160	160	66,70
22 L 160	22	St	66,70	65,94	160	160	70,50
23 L 160	23	St	69,73	68,97	160	160	76,40
24 L 160	24	St	72,77	72,00	160	160	78,00
27 L 160	27	St	81,86	81,10	160	160	131,00
30 L 160	30	St	90,96	90,20	160	160	168,00

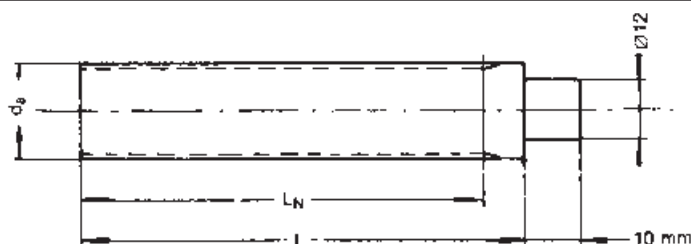

**Type T 5 – Teilung Pitch 5 mm**

Bezeichnung Part No.	Anzahl der Zähne No. of teeth	Material	$d_d$ (mm)	$d_a$ (mm)	$L_N$ (mm)	L (mm)	€ Stück each
125 T 5- 10	10	Al	15,92	15,05	125	140	21,20
125 T 5- 11	11	Al	17,51	16,65	125	140	22,50
125 T 5- 12	12	Al	19,01	18,25	125	140	23,70
125 T 5- 13	13	Al	20,70	19,85	125	140	24,40
132 T 5- 14	14	Al	22,29	21,45	132	140	25,30
132 T 5- 15	15	Al	23,88	23,05	132	140	26,00
140 T 5- 16	16	Al	25,47	24,60	140	140	28,40
140 T 5- 17	17	Al	27,06	26,20	140	140	30,50
140 T 5- 18	18	Al	28,65	27,80	140	140	33,00
140 T 5- 19	19	Al	30,25	29,40	140	140	35,60
160 T 5- 20	20	Al	31,83	31,00	160	160	38,00
160 T 5- 21	21	Al	33,43	32,70	160	160	41,00
160 T 5- 22	22	Al	35,12	34,25	160	160	43,70
160 T 5- 23	23	Al	36,62	35,85	160	160	45,80
160 T 5- 24	24	Al	38,21	37,40	160	160	47,90
160 T 5- 25	25	Al	39,80	39,00	160	160	49,50
160 T 5- 26	26	Al	41,47	40,60	160	160	53,30
160 T 5- 27	27	Al	42,98	42,20	160	160	56,90
160 T 5- 28	28	Al	44,62	43,75	160	160	60,10
160 T 5- 29	29	Al	46,17	45,35	160	160	62,60
160 T 5- 30	30	Al	47,76	46,95	160	160	65,30
160 T 5- 32	32	Al	50,94	50,10	160	160	69,40
160 T 5- 34	34	Al	54,13	53,25	160	160	76,70
160 T 5- 35	35	Al	55,72	54,85	160	160	81,60
160 T 5- 36	36	Al	57,31	56,45	160	160	86,20
160 T 5- 37	37	Al	58,90	58,06	160	160	91,20
160 T 5- 38	38	Al	60,50	59,65	160	160	94,80
160 T 5- 40	40	Al	63,66	62,85	160	160	96,50
160 T 5- 42	42	Al	66,87	66,00	160	160	105,00
160 T 5- 44	44	Al	70,07	69,20	160	160	115,00
160 T 5- 45	45	Al	71,64	70,80	160	160	119,00
160 T 5- 46	46	Al	73,23	72,40	160	160	122,00
160 T 5- 48	48	Al	76,42	75,55	160	160	128,00
160 T 5- 50	50	Al	79,60	78,75	160	160	138,00
160 T 5- 60	60	Al	95,52	94,65	160	160	186,00
160 T 5- 72	72	Al	114,62	113,75	160	160	252,00
160 T 5- 80	80	Al	127,36	126,48	160	160	296,00
160 T 5- 90	90	Al	143,28	142,40	160	160	361,00
160 T 5-100	100	Al	159,20	158,31	160	160	398,00

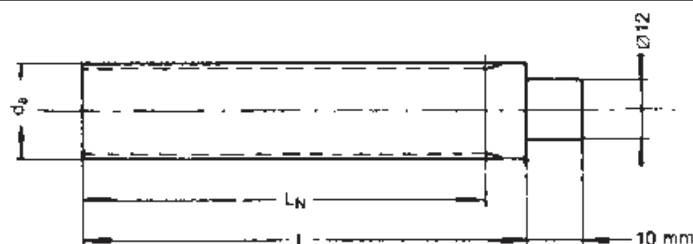

**Type T 10 – Teilung *Pitch* 10 mm**

Bezeichnung Part No.	Anzahl der Zähne No. of teeth	Material	$d_d$ (mm)	$d_a$ (mm)	$L_N$ (mm)	L (mm)	€ Stück each
140 T 10-10	10	Al	31,83	29,98	140	140	29,90
140 T 10-11	11	Al	35,01	33,16	140	140	33,90
140 T 10-12	12	Al	38,20	36,35	140	140	37,60
140 T 10-13	13	Al	41,38	39,50	140	140	42,10
160 T 10-14	14	Al	44,56	42,70	160	160	48,90
160 T 10-15	15	Al	47,75	45,90	160	160	55,90
160 T 10-16	16	Al	50,93	49,05	160	160	63,80
160 T 10-17	17	Al	54,11	52,25	160	160	67,30
160 T 10-18	18	Al	57,29	55,45	160	160	73,50
160 T 10-19	19	Al	60,48	58,60	160	160	77,20
160 T 10-20	20	Al	63,66	61,60	160	160	83,80
160 T 10-21	21	Al	66,84	65,00	160	160	90,60
160 T 10-22	22	Al	70,03	68,15	160	160	96,40
160 T 10-23	23	Al	73,20	71,35	160	160	104,00
160 T 10-24	24	Al	76,39	74,55	160	160	115,00
160 T 10-26	26	Al	82,76	80,90	160	160	129,00
160 T 10-28	28	Al	89,13	87,25	160	160	144,00
160 T 10-30	30	Al	95,49	93,65	160	160	160,00
160 T 10-32	32	Al	101,86	100,00	160	160	195,00
160 T 10-34	34	Al	108,22	106,40	160	160	222,00
160 T 10-36	36	Al	114,59	112,75	160	160	236,00
160 T 10-38	38	Al	120,95	119,10	160	160	266,00
160 T 10-40	40	Al	127,32	125,45	160	160	293,00
160 T 10-45	45	Al	143,24	141,40	160	160	378,00
160 T 10-48	48	Al	152,78	150,95	160	160	427,00
160 T 10-60	60	Al	190,98	189,10	160	160	672,00
160 T 10-72	72	Al	229,18	227,29	160	160	820,00

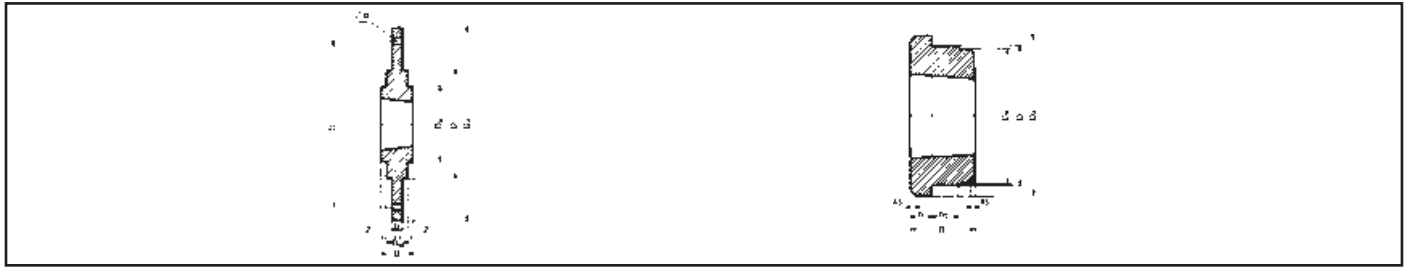

<b>optibelt TN Anschraubnaben – Bolt on hubs</b>													
Bezeichnung Part No.	Material	Taper- Buchse Taper bush	D <sub>A</sub> (mm)	D <sub>T</sub> (mm)	D + 0/- 0,1 (mm)	D <sub>K</sub> (mm)	B (mm)	b (mm)	Z (mm)	B <sub>M</sub> (mm)	d (mm)	Gewicht o. Buchse Weight without bush (= kg)	€ Stück ohne Buchse each without bush
SM 12	GG	1210	180	135	90	75	25	6,5	2,5	11,5	6 x 7,5	1,5	41,30
SM 16	GG	1615	200	150	110	85	38	7,5	2,5	12,5	6 x 7,5	3,0	48,10
SM 20	GG	2012	270	190	140	110	32	8,5	2,5	13,5	6 x 9,5		69,10
SM 25	GG	2517	340	240	170	125	45	9,5	2,5	14,5	8 x 11,5	7,6	108,00
SM 30-1	GG	3020	430	300	220	160	51	13,5	2,5	18,5	8 x 13,5	16,6	155,00
SM 30-2	GG	3020	485	340	250	160	51	13,5	2,5	18,5	8 x 13,5	20,5	244,00

<b>optibelt TN Einschweißnaben Type WM – Weld on hubs type WM</b>										
Bezeichnung Part No.	Material	Taper- Buchse Taper bush	D <sub>A</sub> (mm)	D + 0/- 0,05 (mm)	D <sub>K</sub> (mm)	B + 0,5/- 0,05 (mm)	b <sub>1</sub> (mm)	b <sub>2</sub> (mm)	Gewicht ohne Buchse Weight without bush (= kg)	€ Stück ohne Buchse each without bush
WM 1210	St	1210	70	60	58	25	9	10	0,3	30,90
WM 1615	St	1615	83	70	68	38	16	11	0,6	38,10
WM 2012	St	2012	95	90	88	32	12	12	0,7	40,10
WM 2517	St	2517	127	110	108	44	19	13	1,8	49,90
WM 3030	St	3030	152	130	125	76	25	19	3,5	89,20
WM 3535	St	3535	184	155	151	89	32	25	10,0	159,00
WM 4040	St	4040	225	195	187	102	32	32	13,2	228,00
WM 4545	St	4545	254	220	213	115	38	38	20,1	354,00
WM 5050	St	5050	276	242	228	127	38	38	25,4	549,00

<b>optibelt TN Einschweißnaben Type WH – Weld on hubs type WH</b>										
Bezeichnung Part No.	Material	Taper- Buchse Taper bush	D <sub>A</sub> (mm)	D + 0/- 0,05 (mm)	D <sub>K</sub> (mm)	B + 0,5/- 0,05 (mm)	b <sub>1</sub> (mm)	b <sub>2</sub> (mm)	Gewicht ohne Buchse Weight without bush (= kg)	€ Stück ohne Buchse each without bush
WH 1210	St	1210	70	65	64,5	25	9	10	0,3	30,90
WH 1610	St	1610	80	75	74,5	25	9	10		38,10
WH 2012	St	2012	95	90	89,5	32	12	12		40,10
WH 2517	St	2517	115	110	109,5	44	19	15		49,90
WH 3020	St	3020	145	140	139,5	50	19	15	2,7	89,20
WH 3525	St	3525	190	180	179,5	65	25	25		123,00
WH 3535	St	3535	190	180	179,5	89	32	25	10,0	159,00
WH 4040	St	4040	200	190	189,5	101	32	30		228,00
WH 4545	St	4545	210	200	199,5	115	40	30		354,00
WH 5050	St	5050	230	220	219,5	127	40	35		549,00

Taper-Buchse Taper bush	1210	1610	1615	2012	2517	3020	3030	3525	3535	4040	4545	5050
Bohrung d <sub>2</sub> (mm) von ... bis ... Bore d <sub>2</sub> (mm) from ... to ...	11-32	14-42	14-42	14-50	16-60	25-75	35-75	35-90	35-90	40-100	44-110	70-125
€/Stück each	10,40	12,40	13,00	15,20	19,10	24,80	32,50	66,00	62,60	88,00	112,00	179,00

Bohrungsdurchmesser d<sub>2</sub> siehe Seite 3.  
Bore diameters d<sub>2</sub> see page 3.

Weitere Abmessungen auf Anfrage.  
Further sizes on request.

GG = Grauguss  
GG = Cast iron

St = Stahl  
St = Steel

Fertigungstechnische Änderungen vorbehalten.  
We reserve the right to make technical changes.



Bezeichnung Part No.	Material	Taper- Buchse Taper bush	D (mm)	B (mm)	Nut- querschnitt Keyway dimensions b x h (mm)	minimaler Nabendurchmesser der Scheibe Minimum hub diameter			Gewicht ohne Buchse Weight without bush (= kg)	€ Stück ohne Buchse each without bush
						Material				
						GG	GGG	St		
1008 AM 1008 BM	St St	1008 1008	45 45	22 22	5 x 2,5	71 75	62 67	56 60	0,1 0,1	<b>25,30</b> <b>25,30</b>
1210 AM 1210 BM	St St	1210 1210	60 60	25 25	6 x 3	86 92	79 86	73 83	0,2 0,2	<b>37,90</b> <b>39,60</b>
1610 AM 1610 BM	St St	1610 1610	70 70	25 25	10 x 4	95 102	89 95	83 89	0,3 0,3	<b>45,50</b> <b>47,20</b>
1615 AM 1615 BM	St St	1615 1615	70 70	38 38	10 x 4	95 102	89 95	83 89	0,4 0,4	<b>49,80</b> <b>51,50</b>
2517 AM 2517 BM	St St	2517 2517	105 105	45 45	16 x 4	143 149	133 140	121 127	1,0 1,0	<b>66,60</b> <b>67,40</b>
3030 AM 3030 BM	St St	3030 3030	130 130	76 76	20 x 5	178 187	165 175	156 159	2,5 2,5	<b>115,00</b> <b>117,00</b>
3535 AM 3535 BM	St St	3535 3535	160 160	89 89	22 x 5	222 232	203 213	191 200	5,2 5,2	<b>187,00</b> <b>191,00</b>
4040 AM 4040 BM	St St	4040 4040	185 185	102 102	24 x 5	273 283	248 257	229 238	8,0 8,0	<b>229,00</b> <b>234,00</b>

St = Stahl Steel GG = Grauguss Cast iron GGG = Globularer Grauguss Spheroidal graphite cast iron AM = ohne Keilnut without keyway BM = mit Keilnut with keyway

Taper-Buchse Taper bush	1008	1210	1610	1615	2517	3030	3535	4040
Bohrung d <sub>2</sub> (mm) von ... bis ... Bore d <sub>2</sub> (mm) from ... to ...	10-25	11-32	14-42	14-42	16-60	35-75	35-90	40-100
€/Stück each	<b>6,90</b>	<b>10,40</b>	<b>12,40</b>	<b>13,00</b>	<b>19,10</b>	<b>32,50</b>	<b>62,60</b>	<b>88,00</b>

Bohrungsdurchmesser d<sub>2</sub> siehe Seite 3. Bore diameters d<sub>2</sub> see page 3. Weitere Abmessungen auf Anfrage. Further sizes on request. Fertigungstechnische Änderungen vorbehalten. We reserve the right to make technical changes.

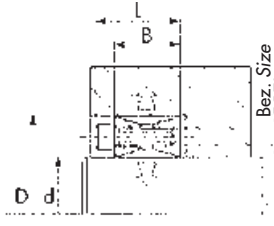

**Type CE01**

Bezeichnung Part No.	Abmessung Dimension				Schrauben Screws			bei Anzugsmoment M <sub>s</sub> übertragbar with tightening torque M <sub>s</sub> applied		Flächen- pression Pressure		Gewicht Weight	€/Stück each
	d	D	B	L	Bezeichnung Part No.	Anzahl No.	Anzugs- moment Tightening torque M <sub>s</sub>	Drehmoment Torque	Axialkraft Axial force	Welle Shaft	Nabe Hub		
								M	F	P <sub>w</sub>	P <sub>N</sub>		
								(N <sub>m</sub> )	(K <sub>N</sub> )	(N/ mm <sup>2</sup> )	(N/ mm <sup>2</sup> )		
(mm)	(mm)	(mm)	(mm)	Stück each	(N <sub>m</sub> )	(K <sub>N</sub> )	(N/ mm <sup>2</sup> )	(N/ mm <sup>2</sup> )	(kg)				
CE01- 18	18	47	20	26	M 6 x 18	8	16	250	28	240	92	0,210	30,70
CE01- 19	19	47	20	26	M 6 x 18	8	16	260	28	225	92	0,210	30,70
CE01- 20	20	47	20	26	M 6 x 18	8	16	280	28	215	92	0,210	30,70
CE01- 22	22	47	20	26	M 6 x 18	8	16	310	28	195	92	0,200	30,70
CE01- 24	24	50	20	26	M 6 x 18	8	16	330	28	180	87	0,222	32,10
CE01- 25	25	50	20	26	M 6 x 18	8	16	350	28	175	87	0,220	32,10
CE01- 28	28	55	20	26	M 6 x 18	12	16	580	42	230	118	0,266	33,40
CE01- 30	30	55	20	26	M 6 x 18	12	16	630	42	215	118	0,254	33,40
CE01- 32	32	60	20	26	M 6 x 18	12	16	670	42	200	110	0,302	36,80
CE01- 35	35	60	20	26	M 6 x 18	12	16	730	42	185	110	0,282	36,80
CE01- 38	38	65	20	26	M 6 x 18	15	16	990	52	215	125	0,328	39,70
CE01- 40	40	65	20	26	M 6 x 18	15	16	1040	52	200	125	0,318	39,70
CE01- 42	42	75	24	32	M 8 x 22	12	38	1600	76	240	140	0,560	45,40
CE01- 45	45	75	24	32	M 8 x 22	12	38	1700	76	225	140	0,528	45,40
CE01- 48	48	80	24	32	M 8 x 22	12	38	1800	76	210	120	0,590	48,50
CE01- 50	50	80	24	32	M 8 x 22	12	38	1900	76	200	130	0,560	48,50
CE01- 55	55	85	24	32	M 8 x 22	15	38	2600	95	230	150	0,622	48,50
CE01- 60	60	90	24	32	M 8 x 22	15	38	2850	95	210	140	0,660	54,90
CE01- 65	65	95	24	32	M 8 x 22	15	38	3100	95	195	130	0,798	57,10
CE01- 70	70	110	28	38	M10 x 25	15	75	5350	150	240	160	1,238	80,60
CE01- 75	75	115	28	38	M10 x 25	15	75	5730	150	225	150	1,294	83,50
CE01- 80	80	120	28	38	M10 x 25	15	75	6100	150	210	140	1,364	85,20
CE01- 85	85	125	28	38	M10 x 25	15	75	6500	150	200	140	1,428	101,00
CE01- 90	90	130	28	38	M10 x 25	15	75	6900	150	185	130	1,482	103,00
CE01- 95	95	135	28	38	M10 x 25	18	75	8700	180	210	150	1,568	108,00
CE01-100	100	145	30	42	M12 x 30	15	130	11200	220	230	160	2,154	128,00
CE01-110	110	155	30	42	M12 x 30	15	130	12300	220	205	150	2,306	133,00
CE01-120	120	165	30	42	M12 x 30	16	130	14300	240	200	150	2,486	138,00
CE01-130	130	180	38	50	M12 x 35	20	130	19400	300	180	130	3,586	198,00
CE01-140	140	190	38	50	M12 x 35	22	130	23000	330	180	140	3,810	212,00
CE01-150	150	200	38	50	M12 x 35	24	130	26900	360	185	140	4,084	235,00
CE01-160	160	210	38	50	M12 x 35	26	130	31000	390	190	150	4,360	261,00
CE01-170	170	225	44	58	M14 x 40	22	200	36300	430	175	140	5,700	298,00
CE01-180	180	235	44	58	M14 x 40	24	200	42000	470	180	140	6,000	334,00
CE01-190	190	250	52	66	M14 x 45	28	200	51800	550	165	130	8,000	451,00
CE01-200	200	260	52	66	M14 x 45	30	200	58300	590	165	130	8,200	489,00
CE01-220*	220	285	56	72	M16 x 50	26	300	74100	680	160	130	11,000	614,00
CE01-240*	240	305	56	72	M16 x 50	30	300	93200	780	170	140	12,300	681,00
CE01-260*	260	325	56	72	M16 x 50	34	300	114500	890	180	150	13,000	956,00
CE01-280*	280	355	66	84	M18 x 60	32	410	141000	1000	160	130	19,000	1.209,00
CE01-300*	300	375	66	84	M18 x 60	36	410	170000	1140	165	140	20,200	1.390,00
CE01-320*	320	405	78	98	M20 x 70	36	590	235500	1500	170	140	30,600	} auf Anfrage on request
CE01-340*	340	425	78	98	M20 x 70	36	590	250000	1500	160	130	30,800	
CE01-360*	360	455	90	112	M22 x 80	36	790	329000	1800	160	130	43,200	
CE01-380*	380	475	90	112	M22 x 80	36	790	346400	1800	150	120	45,000	
CE01-400*	400	495	90	112	M22 x 80	36	790	365000	1800	145	120	46,800	

\* Keine Lagerware Non stock items

Fertigungstechnische Änderungen vorbehalten. We reserve the right to make technical changes.

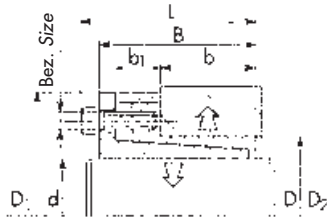

**Type CE02**

Bezeichnung Part No.	Abmessung Dimension								Schrauben Screws			bei Anzugsmoment M <sub>s</sub> übertragbar with tightening torque M <sub>s</sub> applied		Flächen- pression Pressure		Gewicht Weight	€/Stück each															
	d	D	D <sub>1</sub>	D <sub>2</sub>	b	b <sub>1</sub>	B	L	Bezeichnung Part No.	Anzahl No.	Anzugs- moment Tighte- ning torque M <sub>s</sub>	M	F	Welle Shaft P <sub>w</sub>	Nabe Hub P <sub>N</sub>																	
																		(mm)	(mm)	(mm)	(mm)	(mm)	(mm)	(mm)	(mm)	(mm)	(mm)	(mm)	(mm)	(mm)	(mm)	(mm)
																		(mm)	(mm)	(mm)	(mm)	(mm)	(mm)	(mm)	(mm)	Stück each	(N <sub>m</sub> )	(N <sub>m</sub> )	(K <sub>N</sub> )	(N/ mm <sup>2</sup> )	(N/ mm <sup>2</sup> )	(kg)
CE02- 6*	6	14	25	23	9	9,5	21,5	24,5	M 3 x 10	4	2	14	4,8	103	95	0,080	41,90															
CE02- 8*	8	15	27	24	12	10,0	25,0	29,0	M 4 x 10	3	5	28	7,0	104	101	0,100	41,90															
CE02- 10*	10	16	29	26	14	8,5	26,0	30,0	M 4 x 10	4	5	46	9,0	110	108	0,120	41,90															
CE02- 12	12	18	32	28	14	8,5	26,0	30,0	M 4 x 10	4	5	55	9,0	88	96	0,140	41,90															
CE02- 14	14	23	38	33	14	8,5	26,0	30,0	M 4 x 10	4	5	64	9,0	75	75	0,150	41,90															
CE02- 15	15	24	45	40	16	12,5	36,0	42,0	M 6 x 16	4	15	150	19,0	102	132	0,209	41,90															
CE02- 16	16	24	45	40	16	12,5	36,0	42,0	M 6 x 16	4	15	150	19,0	96	132	0,218	41,90															
CE02- 18	18	26	47	43	18	13,0	38,0	44,0	M 6 x 18	4	17	200	23,0	102	129	0,226	41,90															
CE02- 19	19	27	49	44	18	13,0	38,0	44,0	M 6 x 18	4	17	210	23,0	97	125	0,248	41,90															
CE02- 20	20	28	49	44	18	13,0	38,0	44,0	M 6 x 18	4	17	220	23,0	92	120	0,248	43,20															
CE02- 22	22	32	54	49	25	13,0	45,0	51,0	M 6 x 18	4	17	250	23,0	69	76	0,325	44,50															
CE02- 24	24	34	56	51	25	13,0	45,0	51,0	M 6 x 18	4	17	270	23,0	63	71	0,344	44,50															
CE02- 25	25	34	56	51	25	13,0	45,0	51,0	M 6 x 18	4	17	280	23,0	61	71	0,332	47,60															
CE02- 28	28	39	61	56	25	13,0	45,0	51,0	M 6 x 18	6	17	500	34,0	81	93	0,410	47,60															
CE02- 30	30	41	62	57	25	13,0	45,0	51,0	M 6 x 18	6	17	520	34,0	76	89	0,414	47,60															
CE02- 32	32	43	65	59	30	13,0	50,0	56,0	M 6 x 18	8	17	730	46,0	84	94	0,478	56,90															
CE02- 35	35	47	69	64	30	13,0	50,0	56,0	M 6 x 18	8	17	800	46,0	77	86	0,546	56,90															
CE02- 38	38	50	72	67	30	13,0	50,0	56,0	M 6 x 18	8	17	900	46,0	71	81	0,580	61,60															
CE02- 40	40	53	75	70	30	13,0	50,0	56,0	M 6 x 18	8	17	900	46,0	67	76	0,626	61,60															
CE02- 42	42	55	78	73	40	17,0	65,0	73,0	M 8 x 22	8	41	1800	84,0	89	101	0,880	71,70															
CE02- 45	45	59	85	79	40	17,0	65,0	73,0	M 8 x 22	8	41	1900	84,0	84	94	1,028	76,50															
CE02- 48	48	62	87	82	45	17,0	70,0	78,0	M 8 x 22	8	41	2000	84,0	72	79	0,980	83,40															
CE02- 50	50	65	92	85	45	17,0	70,0	78,0	M 8 x 22	10	41	2600	105,0	87	95	1,270	88,30															
CE02- 55	55	71	98	92	50	17,0	75,0	83,0	M 8 x 22	10	41	2900	105,0	73	78	1,480	107,00															
CE02- 60	60	77	104	98	50	17,0	75,0	83,0	M 8 x 22	10	41	3100	105,0	67	72	1,658	120,00															
CE02- 65	65	84	111	105	50	17,0	75,0	83,0	M 8 x 22	10	41	3400	105,0	62	66	1,922	137,00															
CE02- 70	70	90	119	114	60	20,0	91,0	101,0	M10 x 25	10	83	5800	170,0	91	82	2,936	174,00															
CE02- 75	75	95	126	120	60	20,0	91,0	101,0	M10 x 25	10	83	6200	170,0	70	77	2,290	208,00															
CE02- 80	80	100	131	125	65	20,0	96,0	106,0	M10 x 25	12	83	7800	200,0	74	81	3,342	225,00															
CE02- 85	85	106	137	131	65	20,0	96,0	106,0	M10 x 25	12	83	8500	200,0	70	77	3,622	227,00															
CE02- 90	90	112	143	137	65	20,0	96,0	106,0	M10 x 25	15	83	11200	250,0	83	91	3,956	244,00															
CE02- 95*	95	120	153	146	65	20,0	96,0	106,0	M10 x 25	15	83	11800	250,0	78	85	4,460	270,00															
CE02-100*	100	125	162	155	65	24,0	102,0	114,0	M12 x 30	12	145	14600	300,0	82	95	6,000	270,00															





### Type CE03

Bezeichnung Part No.	Abmessung Dimension							bei Anzugsmoment M <sub>s</sub> übertragbar with tightening torque M <sub>s</sub> applied		Flächen- pression Pressure		ges. Axialkraft der Spann- schrauben Total axial force on the tension screws	Gewicht Weight	€/Stück each
	d	D	L	Z				Drehmoment Torque	Axialkraft Axial force	Welle Shaft	Nabe Hub			
				1	2	3	4							
				(mm)	(mm)	(mm)	(mm)							
CE03- 6*	6	9	4,5	3	3	3	4	2	0,8	96	65	4	0,001	7,00
CE03- 8*	8	11	4,5	3	3	3	4	5	1,0	108	80	6	0,001	7,00
CE03- 10*	10	13	4,5	3	3	3	4	10	2,0	112	100	16	0,002	7,00
CE03- 12*	12	15	4,5	3	3	3	4	11	2,0	111	90	16	0,002	7,00
CE03- 14	14	18	6,3	3	4	4	5	22	3,0	112	90	26	0,004	7,00
CE03- 15	15	19	6,3	3	4	4	5	25	3,0	112	90	27	0,004	7,00
CE03- 16	16	20	6,3	3	4	4	5	26	3,0	112	90	27	0,005	7,00
CE03- 17	17	21	6,3	3	4	4	5	30	3,0	112	90	27	0,006	7,00
CE03- 18	18	22	6,3	3	4	4	5	33	3,0	112	90	33	0,006	7,00
CE03- 19	19	24	6,3	3	4	4	5	40	4,0	112	90	33	0,006	7,00
CE03- 20	20	25	6,3	3	4	4	5	44	4,0	112	90	33	0,008	7,00
CE03- 22	22	26	6,3	3	4	4	5	50	4,0	100	90	34	0,010	7,00
CE03- 24	24	28	6,3	3	4	4	5	68	6,0	114	100	34	0,006	7,00
CE03- 25	25	30	6,3	3	4	4	5	75	6,0	120	100	37	0,010	7,00
CE03- 28	28	32	6,3	3	4	4	5	90	6,0	111	100	40	0,008	7,30
CE03- 30	30	35	6,3	3	4	4	5	100	7,0	111	100	40	0,012	7,30
CE03- 32	32	36	6,3	3	4	4	5	120	7,0	111	100	40	0,010	7,30
CE03- 35	35	40	7,0	3	4	4	5	160	9,0	111	100	50	0,015	7,30
CE03- 38	38	44	7,0	4	5	5	6	190	10,0	111	100	60	0,020	7,30
CE03- 40	40	45	8,0	4	5	5	6	230	11,0	111	100	70	0,020	7,30
CE03- 42	42	48	8,0	4	5	5	6	260	12,0	111	100	70	0,025	11,00
CE03- 45	45	52	10,0	4	5	5	6	390	17,0	111	100	110	0,039	11,00
CE03- 48	48	55	10,0	4	5	5	6	430	18,0	111	100	110	0,042	11,00
CE03- 50	50	57	10,0	4	5	5	6	470	19,0	111	100	110	0,044	11,00
CE03- 55	55	62	10,0	4	5	5	6	580	21,0	111	100	120	0,048	13,10
CE03- 60	60	68	12,0	4	5	6	7	840	28,0	111	100	160	0,072	13,10
CE03- 65	65	73	12,0	4	5	6	7	1000	30,0	111	100	160	0,078	15,00
CE03- 70	70	79	14,0	4	5	6	7	1300	38,0	111	100	200	0,112	18,40
CE03- 75	75	84	14,0	4	5	6	7	1500	41,0	111	100	220	0,120	21,60
CE03- 80	80	91	17,0	5	6	7	8	2100	54,0	111	100	300	0,190	24,80
CE03- 85*	85	96	17,0	5	6	7	8	2300	56,0	111	100	310	0,200	33,20
CE03- 90	90	101	17,0	5	6	7	8	2700	61,0	111	100	320	0,212	33,20
CE03- 95*	95	106	17,0	5	6	7	8	3500	73,0	111	100	380	0,230	39,70
CE03-100	100	114	21,0	5	6	8	9	4200	84,0	111	100	440	0,376	39,70
CE03-110*	110	124	21,0	5	6	8	9	4300	86,0	111	90	450	0,410	42,70
CE03-120*	120	134	21,0	5	6	8	9	5100	88,0	111	90	460	0,450	47,00
CE03-130*	130	148	28,0	6	7	9	11	8100	125,0	111	90	650	0,828	63,30
CE03-140*	140	158	28,0	6	7	9	11	9400	135,0	111	90	690	0,898	73,50
CE03-150*	150	168	28,0	6	7	9	11	11000	145,0	111	90	720	0,973	77,90



### Type CE04

Bezeichnung Part No.	Abmessung Dimension				Schrauben Screws			bei Anzugsmoment M <sub>s</sub> übertragbar with tightening torque M <sub>s</sub> applied		Flächen- pressung Pressure		Gewicht Weight	€/Stück each
	d	D	B	L	Bezeichnung Part No.	Anzahl No.	Anzugs- moment Tightening torque M <sub>s</sub>	Drehmoment Torque	Axialkraft Axial force	Welle Shaft	Nabe Hub		
								M	F	P <sub>W</sub>	P <sub>N</sub>		
	(mm)	(mm)	(mm)	(mm)	Stück each	(N <sub>m</sub> )	(N <sub>m</sub> )	(K <sub>N</sub> )	(N/ mm <sup>2</sup> )	(N/ mm <sup>2</sup> )	(kg)		
CE04- 20	20	47	42	48	M 6 x 25	6	17	530	52	190	110	0,384	<b>33,30</b>
CE04- 22	22	47	42	48	M 6 x 25	6	17	580	52	170	110	0,366	<b>33,30</b>
CE04- 24	24	50	42	48	M 6 x 25	6	17	630	52	160	100	0,410	<b>36,70</b>
CE04- 25	25	50	42	48	M 6 x 25	6	17	660	52	150	100	0,402	<b>36,70</b>
CE04- 28	28	55	42	48	M 6 x 25	6	17	740	52	130	100	0,482	<b>36,70</b>
CE04- 30	30	55	42	48	M 6 x 25	6	17	790	52	130	100	0,458	<b>36,70</b>
CE04- 32	32	60	42	48	M 6 x 25	8	17	1180	70	160	120	0,520	<b>38,90</b>
CE04- 35	35	60	42	48	M 6 x 25	8	17	1230	70	140	120	0,510	<b>38,90</b>
CE04- 38	38	65	42	48	M 6 x 25	8	17	1300	70	130	110	0,600	<b>40,10</b>
CE04- 40	40	65	42	48	M 6 x 25	8	17	1400	70	125	110	0,568	<b>40,10</b>
CE04- 42	42	75	50	58	M 8 x 30	6	41	2000	100	130	120	1,020	<b>49,50</b>
CE04- 45	45	75	50	58	M 8 x 30	6	41	2200	100	125	120	0,934	<b>49,50</b>
CE04- 48	48	80	50	58	M 8 x 30	8	41	3200	130	155	150	1,050	<b>51,50</b>
CE04- 50	50	80	50	58	M 8 x 30	8	41	3300	130	150	150	1,008	<b>51,50</b>
CE04- 55	55	85	50	58	M 8 x 30	8	41	3600	130	135	140	1,124	<b>57,30</b>
CE04- 60	60	90	50	58	M 8 x 30	8	41	3900	130	125	130	1,210	<b>60,90</b>
CE04- 65	65	95	50	58	M 8 x 30	8	41	4200	130	115	120	1,234	<b>106,00</b>
CE04- 70	70	110	60	70	M10 x 30	8	83	7500	210	150	130	2,306	<b>115,00</b>
CE04- 75*	75	115	60	70	M10 x 30	8	83	8000	210	140	130	2,466	<b>119,00</b>
CE04- 80	80	120	60	70	M10 x 30	8	83	8500	210	130	120	2,588	<b>120,00</b>
CE04- 85*	85	125	60	70	M10 x 30	10	83	11400	270	155	150	2,700	<b>134,00</b>
CE04- 90	90	130	60	70	M10 x 30	10	83	12000	270	145	140	2,832	<b>138,00</b>
CE04-100	100	145	68	80	M12 x 35	8	145	15000	300	130	120	3,936	<b>177,00</b>
CE04-110*	110	155	68	80	M12 x 35	8	145	16500	300	120	110	4,300	<b>263,00</b>
CE04-120*	120	165	68	80	M12 x 35	10	145	22500	370	135	130	4,600	<b>291,00</b>
CE04-130*	130	180	68	80	M12 x 35	12	145	29300	450	150	140	5,500	<b>327,00</b>
CE04-140*	140	190	76	90	M14 x 40	10	210	32200	460	130	125	6,700	<b>330,00</b>
CE04-150*	150	200	76	90	M14 x 40	12	210	41400	550	145	140	7,000	<b>333,00</b>
CE04-160*	160	210	76	90	M14 x 40	12	210	44100	550	135	130	7,500	<b>343,00</b>
CE04-170*	170	225	76	90	M14 x 40	14	210	54700	640	150	150	8,700	<b>416,00</b>
CE04-180*	180	235	76	90	M14 x 40	14	210	57900	640	140	140	9,200	<b>437,00</b>



### Type CE05

Bezeichnung Part No.	Abmessung Dimension				Schrauben Screws			bei Anzugsmoment $M_s$ übertragbar with tightening torque $M_s$ applied		Flächen- pression Pressure		Gewicht Weight	€/Stück each
	d	D	B	L	Bezeichnung Part No.	Anzahl No.	Anzugs- moment Tightening torque $M_s$	Drehmoment Torque	Axialkraft Axial force	Welle Shaft	Nabe Hub		
								M	F	$P_W$	$P_N$		
(mm)	(mm)	(mm)	(mm)		Stück each	(N <sub>m</sub> )	(N <sub>m</sub> )	(K <sub>N</sub> )	(N/ mm <sup>2</sup> )	(N/ mm <sup>2</sup> )	(kg)		
CE05- 20	20	47	28	34	M 6 x 20	6	14	410	41	218	137	0,260	<b>28,70</b>
CE05- 22	22	47	28	34	M 6 x 20	6	14	450	41	198	137	0,250	<b>28,70</b>
CE05- 24*	24	50	28	34	M 6 x 20	6	14	490	41	182	128	0,276	<b>31,50</b>
CE05- 25	25	50	28	34	M 6 x 20	6	14	510	41	175	128	0,268	<b>31,50</b>
CE05- 28*	28	55	28	34	M 6 x 20	6	14	570	41	156	117	0,322	<b>31,50</b>
CE05- 30	30	55	28	34	M 6 x 20	6	14	610	41	145	117	0,304	<b>32,80</b>
CE05- 32*	32	60	28	34	M 6 x 20	8	14	880	54	182	143	0,370	<b>36,50</b>
CE05- 35	35	60	28	34	M 6 x 20	8	14	960	54	166	143	0,344	<b>36,50</b>
CE05- 38*	38	65	28	34	M 6 x 20	8	14	1040	54	153	132	0,408	<b>38,50</b>
CE05- 40	40	65	28	34	M 6 x 20	8	14	1090	54	145	132	0,378	<b>38,50</b>
CE05- 42*	42	75	33	41	M 8 x 25	8	35	2200	105	201	186	0,630	<b>44,60</b>
CE05- 45	45	75	33	41	M 8 x 25	8	35	2360	105	207	186	0,630	<b>44,60</b>
CE05- 48*	48	80	33	41	M 8 x 25	8	35	2520	105	194	174	0,680	<b>47,50</b>
CE05- 50	50	80	33	41	M 8 x 25	8	35	2620	105	186	174	0,686	<b>47,50</b>
CE05- 55*	55	85	33	41	M 8 x 25	8	35	2890	105	169	164	0,720	<b>55,40</b>
CE05- 60	60	90	33	41	M 8 x 25	8	35	3150	105	155	155	0,794	<b>55,40</b>
CE05- 65*	65	95	33	41	M 8 x 25	8	35	3410	105	143	174	0,842	<b>69,50</b>
CE05- 70*	70	110	40	50	M10 x 30	8	70	5990	170	180	172	1,534	<b>107,00</b>
CE05- 75*	75	115	40	50	M10 x 30	8	70	6420	170	168	165	1,634	<b>117,00</b>
CE05- 80*	80	120	40	50	M10 x 30	8	70	6850	170	158	158	1,722	<b>117,00</b>
CE05- 85*	95	125	40	50	M10 x 30	10	70	9090	210	186	189	1,834	<b>131,00</b>
CE05- 90*	90	130	40	50	M10 x 30	10	70	9630	210	175	182	1,900	<b>135,00</b>
CE05-100*	100	145	44	56	M12 x 30	8	115	11900	240	158	168	2,618	<b>173,00</b>
CE05-110*	110	155	44	56	M12 x 30	8	115	13090	240	144	157	2,788	<b>183,00</b>
CE05-120*	120	165	44	56	M12 x 30	9	115	16060	270	148	166	3,600	<b>185,00</b>
CE05-130*	130	180	52	64	M12 x 30	12	115	23200	360	152	155	4,410	<b>253,00</b>
CE05-140*	140	190	54	68	M14 x 40	9	185	25500	360	138	150	4,920	<b>263,00</b>
CE05-150*	150	200	54	68	M14 x 40	10	185	30300	400	143	158	5,200	<b>309,00</b>
CE05-160*	160	210	54	68	M14 x 40	12	185	38800	490	161	181	5,600	<b>322,00</b>
CE05-180*	180	235	64	78	M14 x 40	12	185	43700	490	119	125	8,500	<b>402,00</b>
CE05-200*	200	260	64	78	M14 x 40	15	185	60700	610	134	141	9,600	<b>523,00</b>

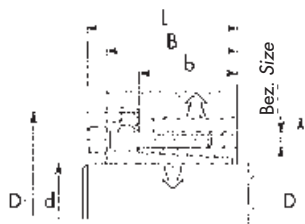

### Type CE06

Bezeichnung Part No.	Abmessung Dimension						Schrauben Screws			bei Anzugsmoment $M_s$ übertragbar with tightening torque $M_s$ applied		Flächen- pression Pressure		Gewicht Weight	€/Stück each
	d	D	D <sub>1</sub>	b	B	L	Bezeichnung Part No.	Anzahl No.	Anzugs- moment Tightening torque $M_s$	Drehmoment	Axialkraft	Welle	Nabe		
										Torque	Axial force	Shaft	Hub		
										M	F	P <sub>w</sub>	P <sub>N</sub>		
(mm)	(mm)	(mm)	(mm)	(mm)	(mm)		Stück each	(N <sub>m</sub> )	(N <sub>m</sub> )	(K <sub>N</sub> )	(N/ mm <sup>2</sup> )	(N/ mm <sup>2</sup> )	(kg)		
CE06- 20	20	47	53	31,0	42	48	M 6 x 25	6	17	320	33	116	70	0,416	37,10
CE06- 22	22	47	53	31,0	42	48	M 6 x 25	6	17	360	33	105	70	0,398	37,10
CE06- 24	24	50	56	31,0	42	48	M 6 x 25	6	17	390	33	97	70	0,442	40,70
CE06- 25	25	50	56	31,0	42	48	M 6 x 25	6	17	400	33	93	70	0,434	40,70
CE06- 28	28	55	61	31,0	42	48	M 6 x 25	6	17	450	33	83	60	0,516	40,70
CE06- 30	30	55	61	31,0	42	48	M 6 x 25	6	17	490	33	77	60	0,492	40,70
CE06- 32	32	60	66	31,0	42	48	M 6 x 25	8	17	690	43	97	70	0,560	44,10
CE06- 35	35	60	66	31,0	42	48	M 6 x 25	8	17	750	43	88	70	0,548	44,10
CE06- 38	38	65	71	31,0	42	48	M 6 x 25	8	17	820	43	81	70	0,650	45,40
CE06- 40	40	65	71	31,0	42	48	M 6 x 25	8	17	860	43	77	70	0,608	45,40
CE06- 42	42	75	81	36,0	50	58	M 8 x 30	6	41	1250	60	82	70	1,090	54,70
CE06- 45	45	75	81	36,0	50	58	M 8 x 30	6	41	1340	60	77	70	1,004	54,70
CE06- 48	48	80	86	36,0	50	58	M 8 x 30	8	41	1910	80	96	90	1,100	56,80
CE06- 50	50	80	86	36,0	50	58	M 8 x 30	8	41	1990	80	92	90	1,074	56,80
CE06- 55	55	85	91	36,0	50	58	M 8 x 30	8	41	2200	80	84	90	1,204	63,80
CE06- 60	60	90	96	36,0	50	58	M 8 x 30	8	41	2400	80	77	80	1,292	70,50
CE06- 65	65	95	101	36,0	50	58	M 8 x 30	8	41	2600	80	71	70	1,308	116,00
CE06- 70	70	110	119	46,0	60	70	M10 x 30	8	83	4600	130	92	80	2,440	124,00
CE06- 75*	75	115	124	46,0	60	70	M10 x 30	8	83	4930	130	86	80	2,596	129,00
CE06- 80	80	120	129	46,0	60	70	M10 x 30	8	83	5200	130	81	70	2,730	131,00
CE06- 85*	85	125	134	46,0	60	70	M10 x 30	10	83	7000	165	95	90	2,800	144,00
CE06- 90	90	130	139	46,0	60	70	M10 x 30	10	83	7400	165	90	80	2,986	149,00
CE06-100	100	145	155	52,0	68	80	M12 x 35	8	145	9700	190	84	80	4,136	193,00
CE06-110*	110	155	165	52,0	68	80	M12 x 35	8	145	10680	190	77	70	4,500	283,00
CE06-120*	120	165	175	52,0	68	80	M12 x 35	10	145	14500	240	88	90	4,800	321,00
CE06-130*	130	180	188	52,0	68	80	M12 x 35	12	145	18900	290	97	100	5,800	360,00
CE06-140*	140	190	199	58,5	76	90	M14 x 40	10	230	22800	325	91	90	7,000	362,00
CE06-150*	150	200	209	58,5	76	90	M14 x 40	12	230	29300	390	102	100	7,300	370,00
CE06-160*	160	210	219	58,5	76	90	M14 x 40	12	230	31300	390	95	100	7,800	389,00
CE06-170*	170	225	234	58,5	76	90	M14 x 40	14	230	38800	460	105	110	9,600	464,00
CE06-180*	180	235	244	58,5	76	90	M14 x 40	14	230	41000	460	99	100	9,000	470,00

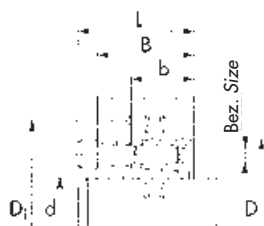

### Type CE07

Bezeichnung Part No.	Abmessung Dimension						Schrauben Screws			bei Anzugsmoment M <sub>s</sub> übertragbar with tightening torque M <sub>s</sub> applied		Flächen- pression Pressure		Gewicht Weight	€/Stück each
	d	D	D <sub>1</sub>	b	B	L	Bezeichnung Part No.	Anzahl No.	Anzugs- moment Tightening torque M <sub>s</sub>	Drehmoment Torque	Axialkraft Axial force	Welle Shaft	Nabe Hub		
										M	F	P <sub>w</sub>	P <sub>N</sub>		
										(N <sub>m</sub> )	(K <sub>N</sub> )	(N/ mm <sup>2</sup> )	(N/ mm <sup>2</sup> )		
(mm)	(mm)	(mm)	(mm)	(mm)	(mm)	Stück each	(N <sub>m</sub> )	(K <sub>N</sub> )	(N/ mm <sup>2</sup> )	(N/ mm <sup>2</sup> )	(kg)				
CE07- 20	20	47	56	22	28	34	M 6 x 20	6	17	320	32	171	100	0,280	<b>28,70</b>
CE07- 22	22	47	56	22	28	34	M 6 x 20	6	17	350	32	156	100	0,270	<b>28,70</b>
CE07- 24	24	50	59	22	28	34	M 6 x 20	6	17	390	32	143	100	0,310	<b>31,50</b>
CE07- 25	25	50	59	22	28	34	M 6 x 20	6	17	400	32	137	100	0,304	<b>31,50</b>
CE07- 28	28	55	64	22	28	34	M 6 x 20	6	17	450	32	122	90	0,362	<b>31,50</b>
CE07- 30	30	55	64	22	28	34	M 6 x 20	6	17	490	32	114	90	0,346	<b>32,80</b>
CE07- 32	32	60	69	22	28	34	M 6 x 20	8	17	700	43	143	110	0,420	<b>36,50</b>
CE07- 35	35	60	69	22	28	34	M 6 x 20	8	17	760	43	131	110	0,390	<b>36,50</b>
CE07- 38	38	65	74	22	28	34	M 6 x 20	8	17	820	43	120	100	0,454	<b>38,50</b>
CE07- 40	40	65	74	22	28	34	M 6 x 20	8	17	870	43	114	100	0,446	<b>38,50</b>
CE07- 42	42	75	84	25	33	41	M 8 x 25	6	41	1700	80	168	140	0,440	<b>44,60</b>
CE07- 45	45	75	84	25	33	41	M 8 x 25	6	41	1800	80	157	140	0,696	<b>44,60</b>
CE07- 48	48	80	89	25	33	41	M 8 x 25	8	41	1900	80	147	130	0,800	<b>47,50</b>
CE07- 50	50	80	89	25	33	41	M 8 x 25	8	41	2000	80	141	130	0,756	<b>47,50</b>
CE07- 55	55	85	91	25	33	41	M 8 x 25	8	41	2200	80	128	120	0,850	<b>55,40</b>
CE07- 60	60	90	99	25	33	41	M 8 x 25	8	41	2400	80	117	120	0,900	<b>55,40</b>
CE07- 65	65	95	104	25	33	41	M 8 x 25	8	41	2600	80	108	110	0,934	<b>69,50</b>
CE07- 70	70	110	119	30	40	50	M10 x 30	8	83	4600	130	138	130	1,670	<b>107,00</b>
CE07- 75	75	115	124	30	40	50	M10 x 30	8	83	5000	130	129	130	1,760	<b>117,00</b>
CE07- 80	80	120	129	30	40	50	M10 x 30	8	83	5300	130	121	120	1,868	<b>117,00</b>
CE07- 85	85	125	134	30	40	50	M10 x 30	10	83	7000	160	142	150	1,966	<b>131,00</b>
CE07- 90	90	130	139	30	40	50	M10 x 30	10	83	7400	160	135	140	2,046	<b>135,00</b>
CE07-100	100	145	154	32	44	56	M12 x 30	8	145	9700	200	129	140	2,830	<b>173,00</b>
CE07-110	110	155	164	32	44	56	M12 x 30	8	145	10700	200	117	130	3,100	<b>183,00</b>
CE07-120	120	165	174	32	44	56	M12 x 30	9	145	13100	220	121	140	3,284	<b>185,00</b>
CE07-130	130	180	189	40	52	64	M12 x 30	12	145	19000	290	124	130	4,600	<b>253,00</b>
CE07-140*	140	190	199	40	54	68	M14 x 40	9	230	20500	300	111	120	4,980	<b>263,00</b>
CE07-150*	150	200	209	40	54	68	M14 x 40	10	230	24500	330	115	130	5,200	<b>309,00</b>
CE07-160*	160	210	219	40	54	68	M14 x 40	12	230	31300	390	130	150	5,600	<b>322,00</b>
CE07-180*	180	235	244	50	64	78	M14 x 40	12	230	35000	390	96	100	8,500	<b>402,00</b>
CE07-200*	200	260	269	50	64	78	M14 x 40	15	230	49000	500	108	110	9,600	<b>523,00</b>

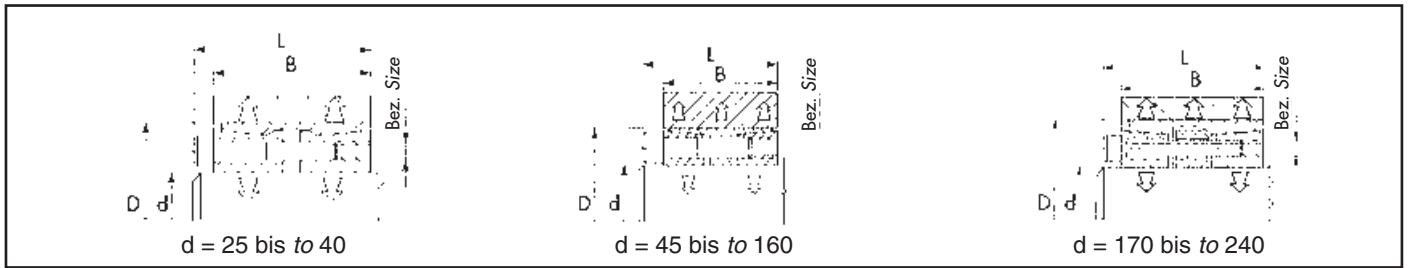

**Type CE08**

Bezeichnung Part No.	Abmessung Dimension				Schrauben Screws			bei Anzugsmoment $M_s$ übertragbar with tightening torque $M_s$ applied		Flächen- pression Pressure		Gewicht Weight	€/Stück each
								Drehmoment Torque	Axialkraft Axial force	Welle Shaft	Nabe Hub		
	d	D	B	L	Bezeichnung Part No.	Anzahl No.	Anzugs- moment Tightening torque $M_s$	M	F	$P_W$	$P_N$		
(mm)	(mm)	(mm)	(mm)		Stück each	(N <sub>m</sub> )	(N <sub>m</sub> )	(K <sub>N</sub> )	(N/ mm <sup>2</sup> )	(N/ mm <sup>2</sup> )	(kg)		
CE08- 25*	25	50	45	51	M 6 x 35	6	17	700	55	157	80	0,415	76,30
CE08- 30*	30	55	45	51	M 6 x 35	8	17	1200	70	175	90	0,464	79,30
CE08- 35*	35	60	45	51	M 6 x 35	8	17	1400	70	150	90	0,526	88,00
CE08- 40*	40	65	45	51	M 6 x 35	10	17	2000	90	164	100	0,550	106,00
CE08- 45	45	75	45	53	M 8 x 35	8	41	3200	140	216	130	0,768	123,00
CE08- 50	50	80	64	72	M 8 x 55	8	41	3600	140	165	80	1,326	141,00
CE08- 55*	55	85	64	72	M 8 x 55	8	41	4000	140	150	80	1,430	155,00
CE08- 60	60	90	64	72	M 8 x 55	10	41	5400	170	171	90	1,524	158,00
CE08- 65*	65	95	64	72	M 8 x 55	10	41	5800	170	158	90	2,000	194,00
CE08- 70	70	110	78	88	M10 x 60	10	83	10300	280	199	100	2,932	228,00
CE08- 75*	75	115	78	88	M10 x 60	10	83	11000	280	186	100	3,100	254,00
CE08- 80	80	120	78	88	M10 x 60	12	83	14000	340	209	110	3,300	262,00
CE08- 85*	85	125	78	88	M10 x 60	12	83	15000	340	197	110	3,400	278,00
CE08- 90	90	130	78	88	M10 x 60	12	83	16000	340	186	100	3,600	282,00
CE08- 95*	95	135	78	88	M10 x 60	12	83	17000	340	176	100	4,000	345,00
CE08-100	100	145	100	112	M12 x 80	12	145	26000	500	198	100	6,000	367,00
CE08-110*	110	155	100	112	M12 x 80	12	145	29000	500	180	100	6,000	414,00
CE08-120*	120	165	100	112	M12 x 80	14	145	36400	600	192	110	6,000	446,00
CE08-130*	130	180	116	130	M14 x 90	12	230	45400	700	174	100	10,100	615,00
CE08-140*	140	190	116	130	M14 x 90	14	230	57000	800	189	110	10,500	756,00
CE08-150*	150	200	116	130	M14 x 90	16	230	70000	900	201	120	11,000	804,00
CE08-160*	160	210	116	130	M14 x 90	16	230	75000	900	189	110	12,000	850,00
CE08-170*	170	225	146	162	M16 x 110	14	355	95000	1100	168	100	17,000	976,00
CE08-180*	180	235	146	162	M16 x 110	15	355	115000	1200	182	110	18,400	1.038,00
CE08-190*	190	250	146	162	M16 x 110	16	355	121500	1200	172	100	21,400	1.211,00
CE08-200*	200	260	146	162	M16 x 110	16	355	128000	1200	163	100	21,800	1.291,00

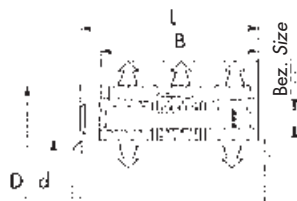

### Type CE09

Bezeichnung Part No.	Abmessung Dimension				Schrauben Screws			bei Anzugsmoment $M_s$ übertragbar with tightening torque $M_s$ applied		Flächen- pression Pressure		Gewicht Weight	
								Drehmoment Torque	Axialkraft Axial force	Welle Shaft	Nabe Hub		
	d	D	B	L	Bezeichnung Part No.	Anzahl No.	Anzugs- moment Tightening torque $M_s$	M	F	$P_W$	$P_N$		
(mm)	(mm)	(mm)	(mm)		Stück each	(N <sub>m</sub> )	(N <sub>m</sub> )	(K <sub>N</sub> )	(N/ mm <sup>2</sup> )	(N/ mm <sup>2</sup> )			
CE09- 45*	45	75	64	72	M 8 x 55	8	41	3200	120	210	125	1,000	<b>185,00</b>
CE09- 50*	50	80	78	86	M 8 x 65	8	41	3550	120	140	65	1,500	<b>201,00</b>
CE09- 60	60	90	78	86	M 8 x 65	10	41	5330	150	146	75	2,000	<b>227,00</b>
CE09- 70	70	110	102	112	M10 x 90	10	83	10260	250	147	75	4,000	<b>342,00</b>
CE09- 80*	80	120	102	112	M10 x 90	12	83	14000	300	154	85	5,000	<b>385,00</b>
CE09- 90*	90	130	102	112	M10 x 90	12	83	15800	300	137	75	6,000	<b>400,00</b>
CE09-100*	100	145	122	134	M12 x 110	12	145	26000	450	149	85	7,000	<b>519,00</b>

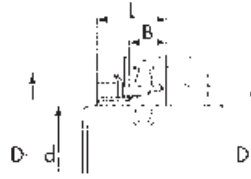

### Type CE10

Bezeichnung Part No.	Abmessung Dimension					Schrauben Screws			bei Anzugsmoment $M_s$ übertragbar with tightening torque $M_s$ applied		Flächen- pression Pressure		Gewicht Weight	
									Drehmoment Torque	Axialkraft Axial force	Welle Shaft	Nabe Hub		
	d	D	D <sub>1</sub>	B	L	Bezeichnung Part No.	Anzahl No.	Anzugs- moment Tightening torque $M_s$	M	F	P <sub>w</sub>	P <sub>N</sub>		
	(mm)	(mm)	(mm)	(mm)	(mm)		Stück each	(N <sub>m</sub> )	(N <sub>m</sub> )	(K <sub>N</sub> )	(N/ mm <sup>2</sup> )	(N/ mm <sup>2</sup> )		
CE10-14	14	25	32	6,5	16,5	M20 x 1,5	1	65	37	6	171	73	0,052	16,10
CE10-15	15	25	32	6,5	16,5	M20 x 1,5	1	65	40	6	159	73	0,050	16,10
CE10-16	16	25	32	6,5	16,5	M20 x 1,5	1	65	42	6	149	73	0,048	17,80
CE10-18	18	30	38	7,0	17,0	M25 x 1,5	1	85	65	8	168	80	0,080	17,80
CE10-19	19	30	38	7,0	17,0	M25 x 1,5	1	95	60	7	136	70	0,078	19,30
CE10-20	20	30	38	7,0	17,0	M25 x 1,5	1	110	70	8	149	80	0,074	19,30
CE10-24	24	35	45	7,0	17,0	M30 x 1,5	1	155	100	10	147	80	0,100	20,30
CE10-25	25	35	45	7,0	17,0	M30 x 1,5	1	160	110	10	146	90	0,092	20,30
CE10-28	28	40	52	8,0	20,0	M35 x 1,5	1	200	140	11	126	70	0,140	22,10
CE10-30	30	40	52	8,0	20,0	M35 x 1,5	1	240	170	14	138	80	0,130	24,20
CE10-32	32	45	58	9,0	22,0	M40 x 1,5	1	320	210	15	135	80	0,170	24,50
CE10-35	35	45	58	9,0	22,0	M40 x 1,5	1	320	230	15	123	80	0,168	24,50
CE10-40	40	50	64	9,0	23,0	M45 x 1,5	1	440	330	19	132	90	0,216	24,50
CE10-45	45	55	70	10,0	25,5	M50 x 1,5	1	550	440	23	127	90	0,266	26,20
CE10-50*	50	60	75	10,0	25,5	M55 x 1,5	1	660	530	25	125	90	0,278	32,60
CE10-60*	60	70	85	12,0	29,5	M65 x 1,5	1	900	830	32	112	80	0,390	32,60



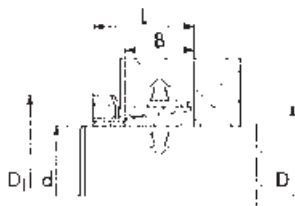

### Type CE11

Bezeichnung Part No.	Abmessung Dimension					Schrauben Screws			bei Anzugsmoment M <sub>s</sub> übertragbar with tightening torque M <sub>s</sub> applied		Flächen- pressung Pressure		Gewicht Weight	€/Stück each
	d	D	D <sub>1</sub>	B	L	Bezeichnung Part No.	Anzahl No.	Anzugs- moment Tightening torque M <sub>s</sub>	Drehmoment	Axialkraft	Welle	Nabe		
									Torque	Axial force	Shaft	Hub		
									M	F	P <sub>W</sub>	P <sub>N</sub>		
(mm)	(mm)	(mm)	(mm)	(mm)		Stück each	(N <sub>m</sub> )	(N <sub>m</sub> )	(K <sub>N</sub> )	(N/ mm <sup>2</sup> )	(N/ mm <sup>2</sup> )	(kg)		
CE11-14	14	25	32	17	29	M20 x 1,5	1	90	90	15	145	80	0,080	24,40
CE11-15	15	25	32	17	29	M20 x 1,5	1	90	100	15	136	80	0,074	24,40
CE11-16	16	25	32	17	29	M20 x 1,5	1	70	80	12	99	60	0,072	24,40
CE11-18	18	30	38	18	31	M25 x 1,5	1	190	200	25	179	110	0,120	25,70
CE11-19	19	30	38	18	31	M25 x 1,5	1	150	170	20	134	90	0,114	25,70
CE11-20	20	30	38	18	31	M25 x 1,5	1	110	130	15	93	60	0,104	25,70
CE11-24	24	35	45	22	35	M30 x 1,5	1	230	270	26	112	80	0,162	27,90
CE11-25	25	35	45	22	35	M30 x 1,5	1	170	200	19	80	60	0,150	27,90
CE11-28	28	40	52	22	35	M35 x 1,5	1	390	460	38	141	110	0,214	27,90
CE11-30	30	40	52	22	35	M35 x 1,5	1	240	300	24	63	70	0,192	27,90
CE11-32	32	45	58	27	42	M40 x 1,5	1	320	420	31	80	70	0,280	32,60
CE11-35	35	45	58	28	42	M40 x 1,5	1	320	460	31	70	60	0,270	32,60
CE11-40	40	50	64	28	44	M45 x 1,5	1	440	640	37	75	70	0,330	32,60
CE11-45	45	55	70	28	45	M50 x 1,5	1	550	760	40	71	60	0,386	40,20
CE11-50	50	60	75	28	46	M50 x 1,5	1	660	930	44	70	60	0,408	44,40
CE11-60	60	70	85	28	52	M65 x 1,5	1	1050	1500	59	79	70	0,550	53,20

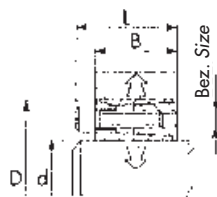

### Type CE12

Bezeichnung Part No.	Abmessung Dimension				Schrauben Screws			bei Anzugsmoment $M_s$ übertragbar with tightening torque $M_s$ applied		Flächen- pression Pressure		Gewicht Weight	
								Drehmoment Torque	Axialkraft Axial force	Welle Shaft	Nabe Hub		
	d	D	B	L	Bezeichnung Part No.	Anzahl No.	Anzugs- moment Tightening torque $M_s$	M	F	$P_W$	$P_N$		
	(mm)	(mm)	(mm)	(mm)		Stück each	(N <sub>m</sub> )	(N <sub>m</sub> )	(K <sub>N</sub> )	(N/ mm <sup>2</sup> )	(N/ mm <sup>2</sup> )		
CE12-16*	16	32	17,0	21,0	M4 x 14	4	5	80	13	134	68	0,070	36,10
CE12-18*	18	40	18,0	24,0	M6 x 15	4	17	180	24	119	100	0,122	41,30
CE12-19*	19	41	18,0	24,0	M6 x 15	4	17	190	24	215	100	0,126	41,30
CE12-20*	20	42	18,0	24,0	M6 x 15	4	17	200	24	204	100	0,130	41,30
CE12-22*	22	44	18,0	24,0	M6 x 15	4	17	220	24	186	90	0,138	41,30
CE12-24*	24	46	18,0	24,0	M6 x 15	6	17	360	36	170	130	0,150	44,40
CE12-25*	25	47	18,0	24,0	M6 x 15	6	17	380	36	245	130	0,160	44,40
CE12-28*	28	50	18,0	24,0	M6 x 15	6	17	420	36	219	120	0,165	46,50
CE12-30*	30	52	18,0	24,0	M6 x 15	6	17	450	36	204	120	0,174	46,50
CE12-32*	32	54	18,0	24,0	M6 x 15	6	17	480	36	191	110	0,184	51,60
CE12-35*	35	57	21,5	27,5	M6 x 15	6	17	520	36	139	90	0,242	51,60
CE12-40*	40	62	21,5	27,5	M6 x 15	8	17	600	36	122	80	0,272	55,20
CE12-45*	45	73	28,0	36,0	M8 x 22	8	41	1700	90	84	130	0,514	65,60
CE12-50*	50	78	28,0	36,0	M8 x 22	8	41	1840	90	187	120	0,570	65,60
CE12-60*	60	88	28,0	36,0	M8 x 22	8	41	2200	90	156	100	0,644	108,00



### Type CE13

Bezeichnung Part No.	Abmessung Dimension				Schrauben Screws			bei Anzugsmoment $M_s$ übertragbar with tightening torque $M_s$ applied		Flächen- pression Pressure		Gewicht Weight	
								Drehmoment Torque	Axialkraft Axial force	Welle Shaft	Nabe Hub		
	d	D	B	L	Bezeichnung Part No.	Anzahl No.	Anzugs- moment Tightening torque $M_s$	M	F	$P_W$	$P_N$		
	(mm)	(mm)	(mm)	(mm)		Stück each	(Nm)	(Nm)	(kN)	(N/ mm <sup>2</sup> )	(N/ mm <sup>2</sup> )		
CE13-15*	15	45	50	56	M 6 x 45	4	17	150	18	81		0,378	45,50
CE13-16*	16	45	50	56	M 6 x 45	4	17	160	18	76		0,370	45,50
CE13-18*	18	50	50	56	M 6 x 45	4	17	180	18	68		0,450	45,50
CE13-19*	19	50	50	56	M 6 x 45	4	17	190	18	64		0,444	45,50
CE13-20*	20	50	50	56	M 6 x 45	4	17	200	18	61		0,436	45,50
CE13-24*	24	55	60	66	M 6 x 55	6	17	360	27	63		0,632	47,00
CE13-25*	25	55	60	66	M 6 x 55	6	17	380	27	60		0,616	54,10
CE13-28*	28	60	60	66	M 6 x 55	6	17	370	24	46		0,752	57,40
CE13-30*	30	60	60	66	M 6 x 55	6	17	400	24	43		0,712	57,40
CE13-35*	35	75	75	83	M 8 x 70	4	41	640	32	41		1,328	75,70
CE13-40*	40	75	75	83	M 8 x 70	4	41	730	32	36		1,188	80,00
CE13-45*	45	85	85	93	M 8 x 80	6	41	1200	48	41		1,716	84,10
CE13-50*	50	90	85	93	M 8 x 80	6	41	1340	48	37		1,884	86,80
CE13-60*	60	100	85	93	M 8 x 80	8	41	2200	64	41		2,174	122,00
CE13-70*	70	115	100	110	M10 x 80	6	83	3200	80	38		4,000	190,00

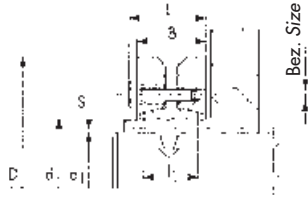

**Type CE14**

Bezeichnung Part No.	Abmessung Dimension							Schrauben Screws			bei Anzugsmoment M <sub>s</sub> übertragbar with tightening torque M <sub>s</sub> applied		Flächen- pression Pressure		Gewicht Weight	€/Stück each
	d	d <sub>1</sub>	D	B	L	l <sub>1</sub>	S	Bez. Size	Anzahl No.	Anzugs- moment Tightening torque M <sub>s</sub>	Drehmoment Torque	Axialkraft Axial force	Welle Shaft	Nabe Hub		
											M	F	P <sub>w</sub>	P <sub>N</sub>		
											(N <sub>m</sub> )	(K <sub>N</sub> )	(N/ mm <sup>2</sup> )	(N/ mm <sup>2</sup> )		
(mm)	(mm)	(mm)	(mm)	(mm)	(mm)	(mm)	Stück each	(N <sub>m</sub> )	(K <sub>N</sub> )	(N/ mm <sup>2</sup> )	(N/ mm <sup>2</sup> )	(kg)				
CE14- 24*	24	19	50	19	23,0	14	0,017	M5	6	4	180	26	140	280	0,184	74,40
		20									27	170	280			
		21									29	200	280			
CE14- 30*	30	24	60	21	25,0	16	0,017	M5	6	4	310	26	200	300	0,288	76,50
		25									27	205	300			
		26									28	220	300			
CE14- 36*	36	28	72	23	27,0	18	0,017	M6	6	12	460	50	235	360	0,468	82,70
		30									54	240	360			
		31									58	260	360			
CE14- 44*	44	32	80	25	29,0	20	0,032	M6	8	12	630	65	225	350	0,590	89,00
		35									74	240	350			
		36									77	255	350			
CE14- 50*	50	38	90	27	31,0	22	0,032	M6	8	12	940	79	180	285	0,794	94,80
		40									85	200	285			
		42									90	220	285			
CE14- 55*	55	42	100	30	34,0	23	0,032	M6	8	12	1200	80	155	250	1,104	103,00
		45									90	180	250			
		48									100	200	250			
CE14- 62*	62	48	110	30	34,0	23	0,032	M6	10	12	1800	100	190	270	1,312	111,00
		50									110	195	270			
		52									120	210	270			
CE14- 68*	68	50	115	30	34,0	23	0,038	M6	10	12	2000	100	140	250	1,304	117,00
		55									110	175	250			
		60									120	210	250			
CE14- 75*	75	55	138	33	38,0	25	0,048	M8	8	30	2500	120	190	300	1,700	121,00
		60									140	220	300			
		65									150	250	300			
CE14- 80*	80	60	145	32	38,0	25	0,048	M8	8	30	3200	120	185	280	2,540	138,00
		65									140	210	280			
		70									160	240	280			
CE14- 90*	90	65	155	39	45,0	30	0,048	M8	10	30	4700	170	180	260	3,300	209,00
		70									190	200	260			
		75									210	220	260			
CE14-100*	100	70	170	44	49,5	34	0,048	M8	12	30	6900	180	165	250	4,410	240,00
		75									220	185	250			
		80									240	190	250			
CE14-110*	110	75	185	50	57,0	39	0,048	M10	10	59	7200	230	160	260	5,900	365,00
		80									250	170	260			
		85									260	185	260			
CE14-115*	115	80	188	50	57,0	39	0,048	M10	10	59	8500	210	150	245	9,000	370,00
		85									240	170	245			
		90									270	180	245			
CE14-125*	125	85	215	54	61,0	42	0,056	M10	12	59	11000	300	160	260	8,600	374,00
		90									320	180	260			
		95									350	190	260			
CE14-130*	130	90	215	52	59,0	42	0,056	M10	12	59	13700	300	160	250	8,700	460,00
		95									330	180	250			
		100									360	190	250			

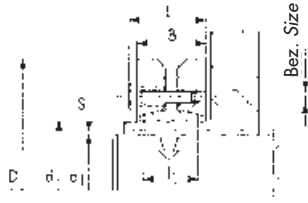

**Type CE14**

Bezeichnung Part No.	Abmessung Dimension							Schrauben Screws			bei Anzugsmoment M <sub>s</sub> übertragbar with tightening torque M <sub>s</sub> applied		Flächen- pression Pressure		Gewicht Weight	€/Stück each
	d	d <sub>1</sub>	D	B	L	l <sub>1</sub>	S	Bez. Size	Anzahl No.	Anzugs- moment Tightening torque M <sub>s</sub>	Drehmoment Torque	Axialkraft Axial force	Welle Shaft	Nabe Hub		
											M	F	P <sub>w</sub>	P <sub>N</sub>		
											(N <sub>m</sub> )	(K <sub>N</sub> )	(N/ mm <sup>2</sup> )	(N/ mm <sup>2</sup> )		
(mm)	(mm)	(mm)	(mm)	(mm)	(mm)	(mm)	Stück each	(N <sub>m</sub> )	(K <sub>N</sub> )	(N/ mm <sup>2</sup> )	(N/ mm <sup>2</sup> )	(kg)				
CE14-140*	140	95 100 105	230	60	68,0	46	0,056	M12	10	100	15000 17000 20000	360 400 420	170 185 195	260 260 260	10,000	<b>591,00</b>
CE14-155*	155	105 110 115	263	62	70,0	50	0,069	M12	12	100	20000 23000 26000	390 420 450	180 190 200	255 255 255	11,500	<b>754,00</b>
CE14-165*	165	115 120 125	290	68	78,0	56	0,069	M16	8	250	36000 39000 44000	630 660 700	195 200 210	265 265 265	20,600	<b>851,00</b>
CE14-175*	175	125 130 135	300	68	78,0	56	0,079	M16	8	250	40000 44000 49000	650 680 720	185 190 200	250 250 250	21,400	<b>878,00</b>
CE14-185*	185	135 140 145	330	86	96,0	71	0,079	M16	10	250	55000 60000 65000	815 875 896	175 185 190	230 230 230	33,400	<b>1.030,00</b>
CE14-195*	195	140 150 155	350	86	96,0	71	0,079	M16	12	250	66000 76000 82000	950 1000 1100	210 220 230	265 265 265	38,000	<b>1.595,00</b>
CE14-220*	220	160 165 170	370	104	114,0	88	0,079	M16	15	250	95000 102000 110000	1200 1300 1300	190 195 200	235 235 235	54,000	<b>1.924,00</b>
CE14-240*	240	170 180 190	405	109	122,0	92	0,079	M20	12	490	120000 140000 160000	1500 1600 1700	210 220 225	260 260 260	67,000	<b>2.519,00</b>
CE14-260*	260	190 200 210	430	120	133,0	103	0,090	M20	14	490	165000 185000 205000	1700 1900 2000	205 220 225	250 250 250	82,000	<b>2.964,00</b>

\* Keine Lagerware Non stock items

Fertigungstechnische Änderungen vorbehalten. We reserve the right to make technical changes.

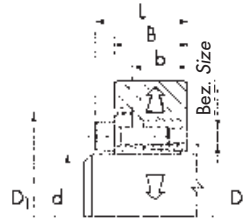

**Type CE16**

Bezeichnung Part No.	Abmessung Dimension						Schrauben Screws			bei Anzugsmoment $M_s$ übertragbar with tightening torque $M_s$ applied		Flächen- pressung Pressure		Gewicht Weight	€/Stück each
	d	D	D <sub>1</sub>	b	B	L	Bezeichnung Part No.	Anzahl No.	Anzugs- moment tightening torque $M_s$	Drehmoment Torque	Axialkraft Axial force	Welle Shaft	Nabe Hub		
										M	F	P <sub>w</sub>	P <sub>N</sub>		
										(N <sub>m</sub> )	(K <sub>N</sub> )	(N/ mm <sup>2</sup> )	(N/ mm <sup>2</sup> )		
(mm)	(mm)	(mm)	(mm)	(mm)	(mm)		Stück each	(N <sub>m</sub> )	(K <sub>N</sub> )	(N/ mm <sup>2</sup> )	(N/ mm <sup>2</sup> )	(kg)			
CE16-14x55*	14	55	62	23	31	39	M8 x 25	4	41	287	41	311	103	0,480	37,40
CE16-16x55*	16	55	62	23	31	39	M8 x 25	4	41	329	41	272	103	0,460	37,40
CE16-18x55*	18	55	62	23	31	39	M8 x 25	4	41	370	41	242	103	0,450	37,40
CE16-19x55*	19	55	62	23	31	39	M8 x 25	4	41	390	41	229	103	0,440	37,40
CE16-20x55*	20	55	62	23	31	39	M8 x 25	4	41	410	41	218	103	0,440	37,40
CE16-22x55*	22	55	62	23	31	39	M8 x 25	4	41	451	41	198	103	0,420	37,40
CE16-24x55*	24	55	62	23	31	39	M8 x 25	4	41	492	41	182	103	0,410	37,40
CE16-25x55*	25	55	62	23	31	39	M8 x 25	4	41	513	41	174	103	0,410	37,40
CE16-28x55*	28	55	62	23	31	39	M8 x 25	4	41	575	41	156	103	0,390	37,40
CE16-30x55*	30	55	62	23	31	39	M8 x 25	4	41	616	41	145	103	0,370	37,40
CE16-24x65*	24	65	72	23	31	39	M8 x 25	5	41	616	51	227	111	0,600	43,60
CE16-25x65*	25	65	72	23	31	39	M8 x 25	5	41	641	51	218	111	0,600	43,60
CE16-28x65*	28	65	72	23	31	39	M8 x 25	5	41	718	51	194	111	0,580	43,60
CE16-30x65*	30	65	72	23	31	39	M8 x 25	5	41	770	51	182	111	0,570	43,60
CE16-32x65*	32	65	72	23	31	39	M8 x 25	5	41	821	51	170	111	0,540	43,60
CE16-35x65*	35	65	72	23	31	39	M8 x 25	5	41	898	51	156	111	0,520	43,60
CE16-38x65*	38	65	72	23	31	39	M8 x 25	5	41	975	51	143	111	0,480	43,60
CE16-40x65*	40	65	72	23	31	39	M8 x 25	5	41	1026	51	136	111	0,460	43,60
CE16-30x80*	30	80	88	26	34	42	M8 x 25	7	41	1077	72	227	108	1,040	53,40
CE16-32x80*	32	80	88	26	34	42	M8 x 25	7	41	1150	72	213	108	1,000	53,40
CE16-35x80*	35	80	88	26	34	42	M8 x 25	7	41	1257	72	194	108	0,960	53,40
CE16-38x80*	38	80	88	26	34	42	M8 x 25	7	41	1364	72	179	108	0,930	53,40
CE16-40x80*	40	80	88	26	34	42	M8 x 25	7	41	1436	72	170	108	0,900	53,40
CE16-42x80*	42	80	88	26	34	42	M8 x 25	7	41	1509	72	162	108	0,900	53,40
CE16-45x80*	45	80	88	26	34	42	M8 x 25	7	41	1616	72	151	108	0,870	53,40
CE16-48x80*	48	80	88	26	34	42	M8 x 25	7	41	1723	72	142	108	0,850	53,40
CE16-50x80*	50	80	88	26	34	42	M8 x 25	7	41	1796	72	136	108	0,820	53,40

Nachdruck, auch auszugsweise, verboten. *Reproduction, in full or part is forbidden.*

Zuwerhandlungen werden urheberrechtlich verfolgt. *Any infringement will be prosecuted under the copyright act law.*

Irrtum sowie Änderungen durch technischen Fortschritt vorbehalten. *Subject to correction or change without notice due to technological progress.*

Bezüglich der Haftung und Lieferung verweisen wie auf unsere allgemeinen Geschäftsbedingungen.

*Concerning liability and delivery refer to our general terms and conditions.*

Die allgemeinen Verkaufsbedingungen sind in der jeweils gültigen Fassung auf der Internetseite unter [www.optibelt.com](http://www.optibelt.com) einzusehen. Auf Wunsch können Ihnen diese zugesandt werden.  
*The latest version of the general conditions of sale can be viewed on the Internet under [www.optibelt.com](http://www.optibelt.com). We can send it to you on request.*



**optibelt VB**  
Klassische Keilriemen  
Classical V-belts

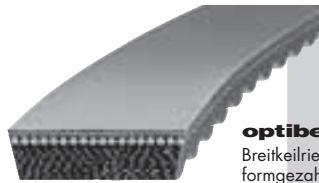

**optibelt SUPER VX**  
Breitkeilriemen, flankenoffen,  
formgezahnt  
Variable speed belts,  
raw edge, moulded cogged

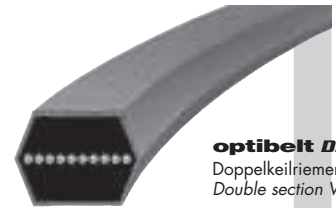

**optibelt DK**  
Doppelkeilriemen  
Double section V-belts

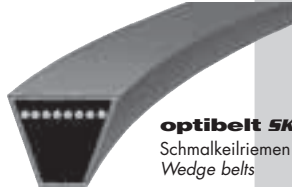

**optibelt SK**  
Schmalkeilriemen  
Wedge belts



**optibelt SUPER DVX**  
Doppel-Breitkeilriemen,  
flankenoffen, formgezahnt  
Double section variable speed  
belts, raw edge, moulded cogged

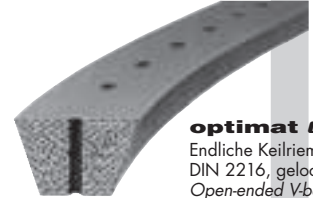

**optimat OE**  
Endliche Keilriemen  
DIN 2216, gelocht  
Open-ended V-beltting,  
punched



**optibelt RED POWER II**  
Hochleistungs-Schmalkeilriemen,  
wartungsfrei  
High performance wedge belts,  
service-free

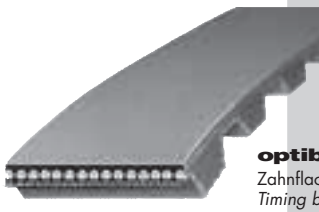

**optibelt ZR**  
Zahnflachriemen  
Timing belts



**optibelt RR**  
Kunststoffrundriemen  
Plastic round section  
beltting



**optibelt Super X-POWER M=5**  
Keilriemen, flankenoffen, formgezahnt  
V-belts, raw edge, moulded cogged

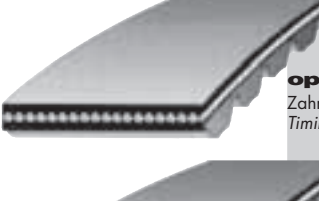

**optibelt OMEGA**  
Zahnflachriemen, wartungsfrei  
Timing belts, service-free



**optibelt RB**  
Rippenbänder  
Ribbed belts



**optibelt KB**  
Kraftbänder  
Kraftbands



**optibelt OMEGA HL**  
**optibelt OMEGA HP**  
Hochleistungs-Zahnflachriemen,  
wartungsfrei  
High performance timing belts,  
service-free



**optibelt KK**  
Kunststoffkeilriemen  
Plastic V-beltting

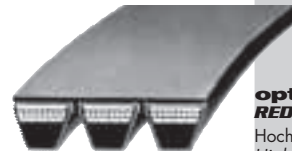

**optibelt KB RED POWER II**  
Hochleistungs-Kraftbänder  
High performance kraftbands



**optibelt HTD® D**  
Doppel-Zahnflachriemen  
Double section timing belts



**optibelt KS**  
Keilrillenscheiben  
V-grooved pulleys



**optibelt KBX**  
Kraftbänder, flankenoffen  
Kraftbands, raw edge



**optibelt ALPHA**  
**optibelt ALPHA linear/V**  
**optibelt ALPHAflex**  
Zahnflachriemen aus Polyurethan  
Polyurethane timing belts

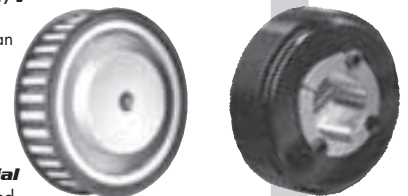

**optibelt ZR5**  
Zahnriemenscheiben  
Timing belt pulleys

**optibelt RB5**  
Rippenbandscheiben  
Ribbed belt pulleys

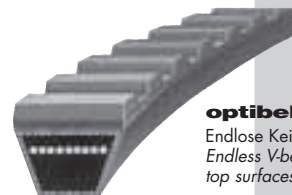

**optibelt PKR**  
Endlose Keilriemen mit Auflage  
Endless V-belts with special  
top surfaces

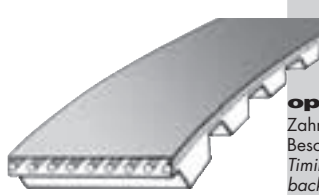

**optibelt ALPHA Spezial**  
Zahnflachriemen mit Nocken und  
Beschichtungen  
Timing belts with cleats and  
back coverings